



CENTRIFUGAL IMMERSION PUMPS

FLUX CENTRIFUGAL IMMERSION PUMPS – QUALITY THAT SETS STANDARDS

Manufactured at our main plant, these ranges of immersion pumps are the result of extensive product and process evaluation by our research and development department.

They are a true FLUX product, from conception through to manufacture, assembly and testing. Their design philosophy, and the materials selected for their construction make them ideal for applications in the chemical industry, surface treatment, electroplating, printed circuit manufacturing, water treatment and wastewater treatment.

FLUX centrifugal immersion pumps can be used whenever liquids have to be transferred or circulated. They are suitable for use with a wide variety of acids and alkalis as well as other chemicals, typically coolants, lubricants and non-flammable solvents.

With delivery rates of up to 74 m³/h and delivery heads of maximum 35 m water column, FLUX centrifugal immersion pumps combine maximum efficiency with a robust and reliable construction, resulting in a pump that provides the ultimate in process security. These are features that you can rely on, each hour, 24 hours a day.

The mechanical seal types F 620 and F 640 are designed for typical liquid transfer operations, with either stationary or portable variants. These units compliment the well-proven barrel pumps range and have a higher output and kW-rating.

Top of the range, are the sealless units, these pumps complete the range of high output, high reliability immersion pumps. Designed for continuous use with a wide range of aggressive liquids, from acids to alkalis, the range includes the type F 706 – with only a sleeve bearing in contact with the liquid – or the types F 716 and F 726 - with a suspended free-flying shaft and no bearings or seals in contact with the liquid.

Three-phase drive motors are available as matched power units in kW-ratings from 0.37 to 5.5 kW, protected to IP 55 as well as explosion-proof to EEx e II T3 for models F 620, F 640, F 706 and F 726.

With immersion lengths from 300 to 4000 mm almost every application requirement can be met. The use of high-class materials such as Hastelloy C and polyvinylidene fluoride, together with polypropylene and stainless steel, are combined with design experience perfected over decades of pump manufacturing. This guarantees the long service life of FLUX centrifugal immersion pumps.

Detailed information and performance charts are shown on the following pages.

To receive a quotation compiled to your application, please could you to fill in the questionnaire on page 22.2 and return it to us.



INNOVATORS IN FLOW TECHNOLOGY

SAFE, POWERFUL, RELIABLE – THE NEW FLUX RANGE

With 4 different design formats within the vertical centrifugal immersion pump range FLUX offer a cost effective, reliable solution for many liquid transfer and circulating operations. With these pumps FLUX meet the requirements of the market with their forward-looking designs and the manufacture of high quality products.



Type F 620 and F 640:
with mechanical seal in vertical and horizontal version

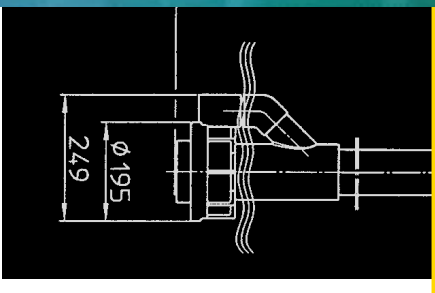

Type F 700:
4 different sizes, sealless design with sleeve bearing, immersion length up to 20

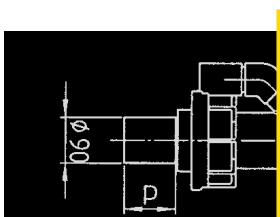

Type F 716:
compact design requires little space for installation, version with support tube or support bars for continuous use, suitable for dry operation

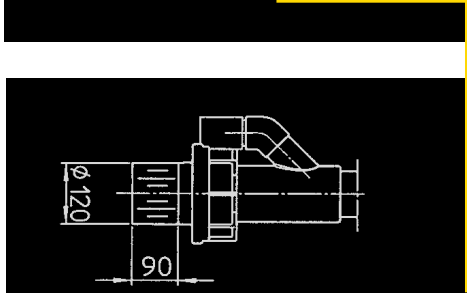

Type F 720:
very robust construction with shaft bearing located in a pedestal, version with support bars for continuous use, suitable for dry operation

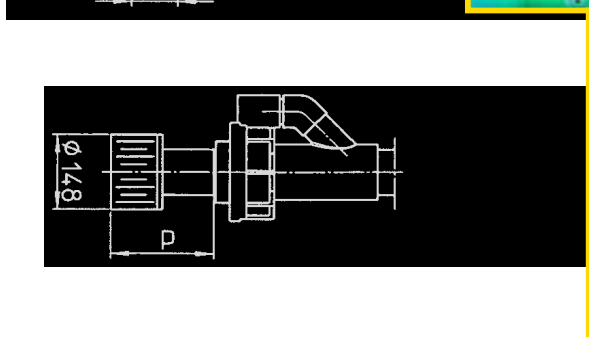

TABLE OF CONTENTS

2-3	Introduction Table of contents
4-5	FLUX Centrifugal Immersion Pumps F 620 S Size 15 and 30 in stainless steel for delivery rates of up to 23 m ³ /h
6-7	FLUX Centrifugal Immersion Pumps F 640 PP Size 15, 30, 15 Z and 30 Z in polypropylene for delivery rates of up to 34 m ³ /h
8-9	FLUX Centrifugal Immersion Pumps F 640 PP and F 640 PVDF Size 185 in polypropylene or polyvinylidene fluoride for delivery rates of up to 40 m ³ /h
10-11	FLUX Centrifugal Pumps F 620 S TR and F 640 PP TR in horizontal version for delivery rates of up to 44 m ³ /h
12-13	FLUX Centrifugal Immersion Pumps F 706 PP Size 135, 185, 230 and 350 in polypropylene for delivery rates of up to 74 m ³ /h
14-15	FLUX Centrifugal Immersion Pumps F 716 PP and F 716 PVDF Size 115 and 135 in polypropylene or polyvinylidene fluoride for delivery rates of up to 12 m ³ /h
16-17	FLUX Centrifugal Immersion Pumps F 716 PP and F 716 PVDF Size 185 and 230 in polypropylene or polyvinylidene fluoride for delivery rates of up to 45 m ³ /h
18-19	FLUX Centrifugal Immersion Pumps F 726 PP and F 726 PVDF Size 115 and 135 in polypropylene or polyvinylidene fluoride for delivery rates of up to 12 m ³ /h
20-21	FLUX Centrifugal Immersion Pumps F 726 PP and F 726 PVDF Size 185 and 230 in polypropylene or polyvinylidene fluoride for delivery rates of up to 45 m ³ /h
22-23	Dimensions of three-phase motors Questionnaire The great range of FLUX pumps

FLUX CENTRIFUGAL IMMERSION PUMP F 620 S IN STAINLESS STEEL SIZE 15 AND 30

Typical Applications

Transferring low flammability liquids up to a viscosity of 2500 mPas (cP) from containers or tanks, either open topped or closed.
Suitable for stationary or portable applications.

Construction features

Centrifugal pump in stainless steel consisting of an inner tube and outer tube.

The centrifugal impeller in the pump housing is driven by the motor via the drive shaft. The drive shaft is supported by intermediate bearings within the inner tube, a mechanical seal separates the liquid from the bearings and upper shaft. This construction provides the ultimate in stability, and ensures the maximum integrity of the mechanical seal. With an open conical impeller.

Three-phase motors in differing kW-ratings are available as a matched power unit. Connection to the pump is made via a flexible coupling.



F 620 S-30
with suction strainer

CONSTRUCTION FEATURES IN DETAIL

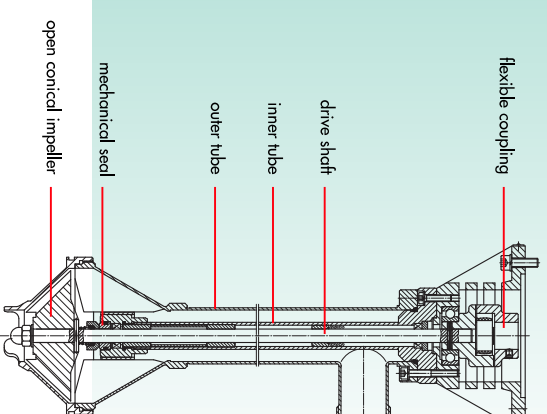

TECHNICAL DATA
Performance chart FLUX F 620 S-15 and F 620 S-30

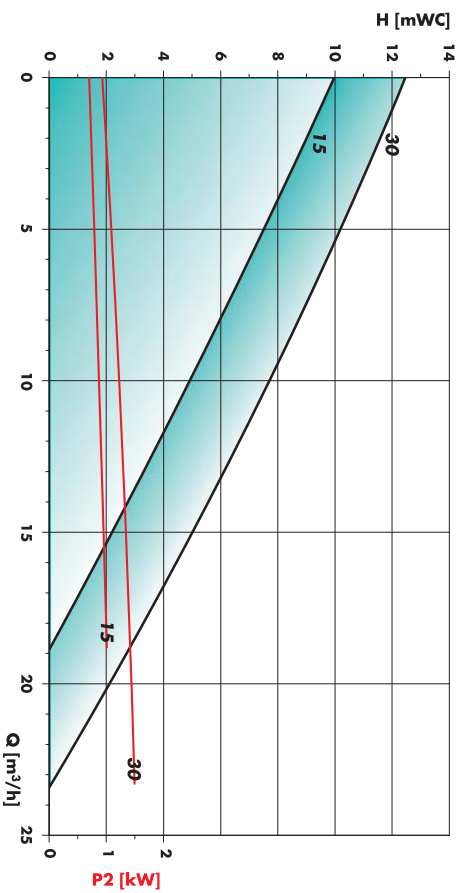

Measured values $\pm 10\%$ determined with water (20 °C). Nominal speed $n = 2850$ rpm

In determining the absorbed kW of the motor, multiply the absorbed kW shown in the above diagram with the specific gravity of the liquid to be pumped.

TECHNICAL DATA
Dimensions F 620 S-15 and F 620 S-30

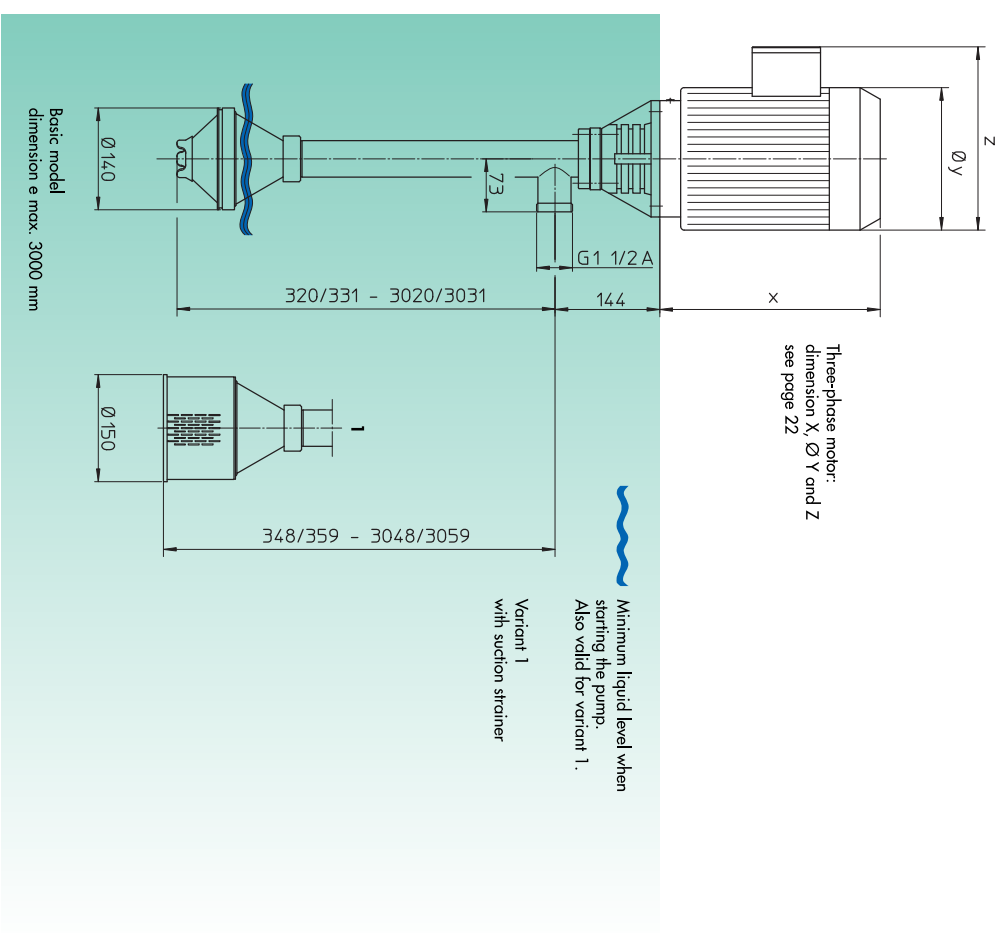

CENTRIFUGAL IMMERSION PUMP F 620 S, THREAD ON OUTLET G 1/4 A (BSP 1/2" MALE), WITHOUT DRIVE MOTOR

Type / Size	F 620 S-15	F 620 S-30
Delivery rate Q max.	19 m ³ /h	23 m ³ /h
Delivery head H max.	10 m water column	12 m water column
Viscosity max.	2500 mPas (cP)	2500 mPas (cP)
Temperature max.	100 °C	100 °C
Seal type		mechanical seal in ceramic oxide, or-rings in FPM
Material		shaft in stainless steel 1.4571/316 Ti, seal in FPM
Impeller		conical impeller in polypropylene (version in stainless steel on request)
Pump housing	Ø 140 mm	Ø 140 mm
Part No.	620 23 001	621 23 001
Immersion length	700 mm	1000 mm
	620 23 002	621 23 002
	1500 mm	621 23 003
	620 23 003	
Part numbers for immersion length 300 to 3000 mm (in steps of 100 mm) on request.		
Accessories:		Part No.
Mounting flange in stainless steel 1.4571/316 Ti		947 14 005
outside Ø 265 mm, pitch circle Ø 225 mm, 8 bores Ø 18 mm each		
Suction strainer in stainless steel 1.4571/316 Ti		001 10 232
for hose inside diameter DN 25		
for hose inside diameter DN 32		959 04 002
for hose inside diameter DN 38		959 04 003
		959 04 004

DRIVE MOTORS FOR CENTRIFUGAL IMMERSION PUMP F 620 S

Three-phase motors protected to IP 55, with motor protection switch or cable terminal box

P2	Capacity	Voltage	Frequency	Nominal speed	Part No.	Part No.
0,75 kW	230/400 V	50 Hz	2850 rpm	Version with motor protection switch	001 00 046	Version with cable terminal box
1,1 kW	230/400 V	50 Hz	2850 rpm		001 00 047	001 00 006
1,5 kW	230/400 V	50 Hz	2850 rpm		001 00 048	001 00 008
2,2 kW	230/400 V	50 Hz	2850 rpm		001 00 049	001 00 009
3,0 kW	400 V	50 Hz	2850 rpm		001 00 050	001 00 010
4,0 kW	400 V	50 Hz	2850 rpm		001 00 051	001 00 011

Three-phase motors explosion-proof to EX e II T3 with cable terminal box

P2	Capacity	Voltage	Frequency	Nominal speed	Part No.	Part No.
0,75 kW	230/400 V	50 Hz	2850 rpm	Version with cable terminal box	001 00 066	Motor protection switch with cable terminal box
1,1 kW	230/400 V	50 Hz	2850 rpm		001 00 067	Version with cable terminal box
1,5 kW	230/400 V	50 Hz	2850 rpm		001 00 068	Version with cable terminal box
2,0 kW	230/400 V	50 Hz	2850 rpm		001 00 069	Version with cable terminal box
2,5 kW	400 V	50 Hz	2850 rpm		001 00 070	Version with cable terminal box
3,3 kW	400 V	50 Hz	2850 rpm		001 00 071	Version with cable terminal box

Accessories:		Part No.
Carrying handle for three-phase motors up to 3,0 kW		001 10 504
Carrying handle for three-phase motors up to 4,0 kW		001 10 531
Carrying handle for three-phase motors explosion-proof up to 3,3 kW		001 10 567

SCORE OF SUPPLY

A complete vertical centrifugal immersion pump consists of: drive motor, pump and necessary accessories.

Weight per pump: 15 – 45 kg depending on the pump size, immersion length and motor kW.

CENTRIFUGAL IMMERSION PUMPS F 620 S

FLUX CENTRIFUGAL IMMERSION PUMP F 640 PP IN POLYPROPYLENE SIZE 15, 30, 15 Z AND 30 Z

Typical applications

Transferring low flammability liquids up to a viscosity of 2500 mPas (cP) from containers, tanks, either open topped or closed.
Transferring corrosive liquids in chemical processing and engineering, melt-working and electroplating together with water treatment and waste water treatment. Suitable for stationary or portable application.

Construction features

Vertical centrifugal immersion pump in polypropylene consisting of an inner tube and outer tube.

The centrifugal impeller in the pump housing is driven by the motor via the drive shaft. The drive shaft is supported by intermediate bearings within the plastic sleeved steel inner tube, a mechanical seal separating the liquid from the bearings and upper shaft. This construction provides the ultimate in stability, preventing elongation of the plastic at high temperatures and ensures the maximum integrity of the mechanical seal.
With an open conical impeller or a closed centrifugal impeller (Z).
The liquid is delivered between the inner and outer tubes to the pump outlet.

Three-phase motors in differing kW-ratings are available as a matched power unit. Connection to the pump is made via a flexible coupling.

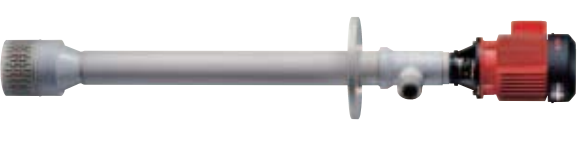

F 640 PP-30 with suction strainer

CONSTRUCTION FEATURES IN DETAIL

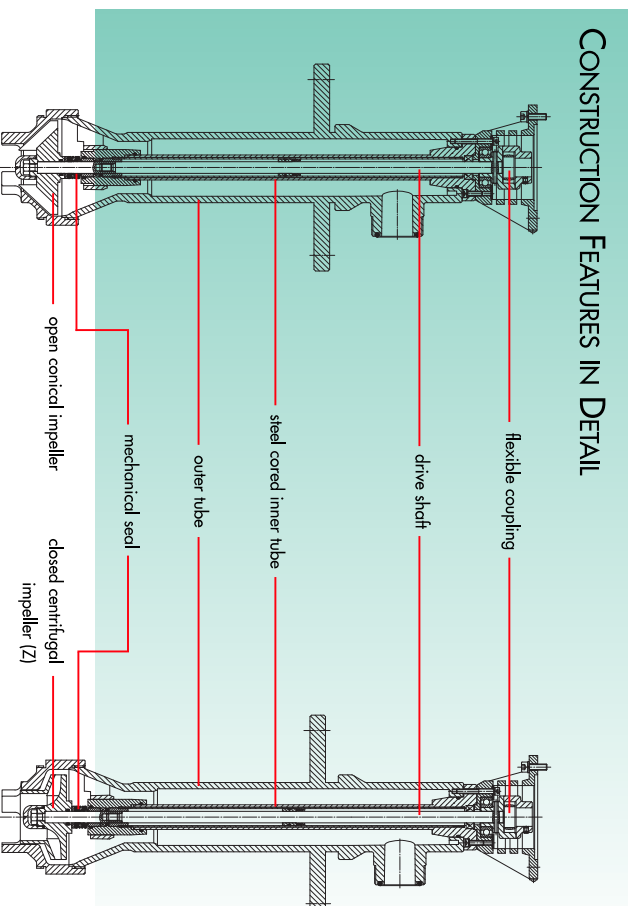

TECHNICAL DATA

Performance chart F 640 PP-15, F 640 PP-30, F 640 PP-15 Z and F 640 PP-30 Z

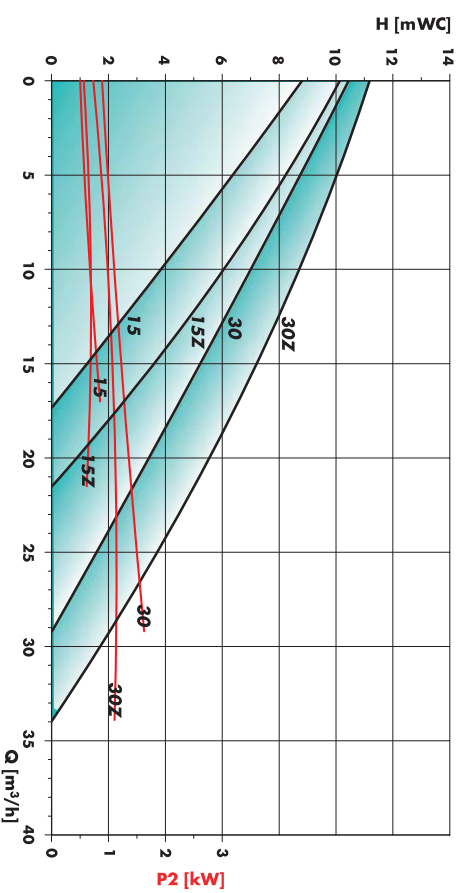

Measured values $\pm 10\%$ determined with water (20 °C). Nominal speed $n = 2850$ rpm

In determining the absorbed kW of the motor, multiply the absorbed kW shown in the above diagram with the specific gravity of the liquid to be pumped.

TECHNICAL DATA

Dimensions F 640 PP-15, F 640 PP-30, F 640 PP-15 Z and F 640 PP-30 Z

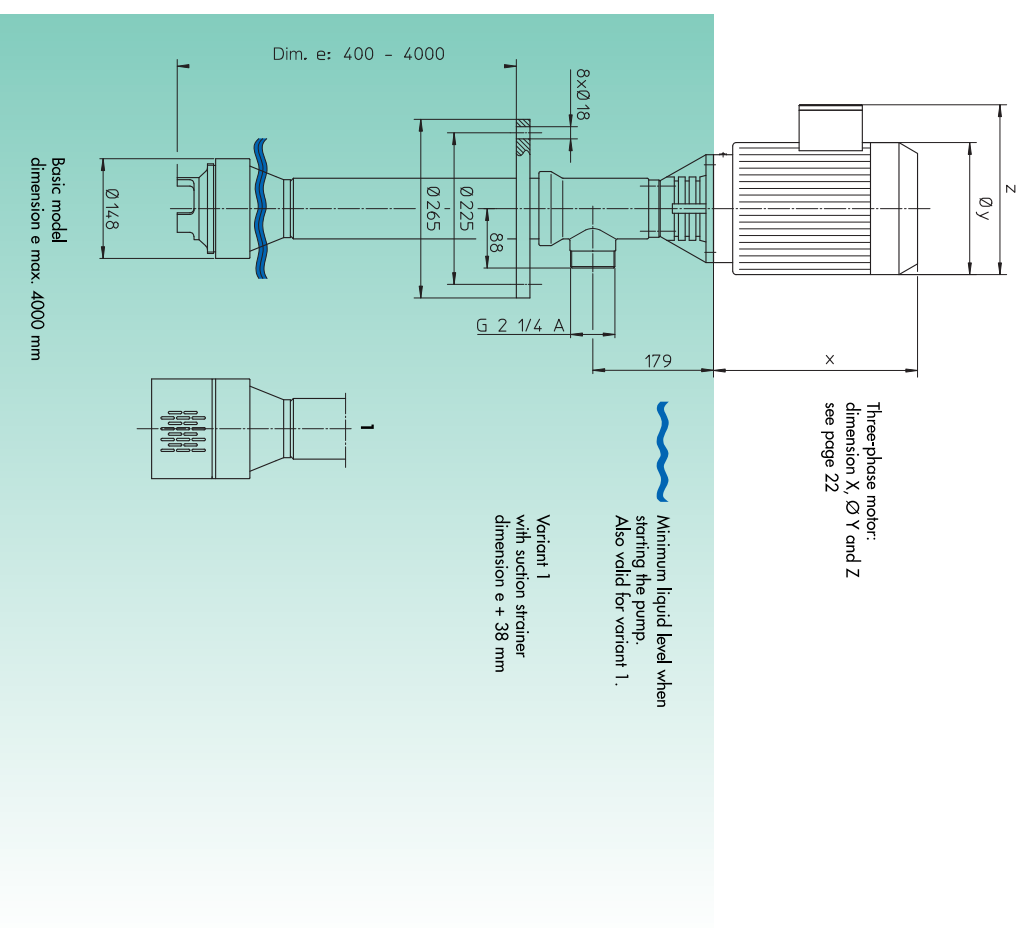

CENTRIFUGAL IMMERSION PUMP F 640 PP, THREAD ON OUTLET G 2 1/4 A (BSP 2 1/4" MALE), WITHOUT DRIVE MOTOR

Type / Size	F 640 PP-15	F 640 PP-30	F 640 PP-15Z	F 640 PP-30Z
Delivery rate Q max.	17 m³/h	29 m³/h	21 m³/h	34 m³/h
Delivery head H max.	8 m water column	10 m water column	10 m water column	11 m water column
Viscosity max.	2500 mPas (cP)	2500 mPas (cP)	150 mPas (cP)	150 mPas (cP)
Temperature max.	50 °C	50 °C	50 °C	50 °C
Seal type		mechanical seal in ceramic oxide / SiC, O-rings in FPM		
Material		shaft in Hastelloy C, seals in FPM		
Impeller		open conical impeller in PP	closed centrifugal impeller in PP	
Pump housing	Ø 148 mm	Ø 148 mm	Ø 148 mm	Ø 148 mm
Mounting flange*		outside Ø 265 mm, pitch circle Ø 225 mm, 8 bores Ø 18 mm each		
Part No.				
Immersion length	700 mm	640 41 607	640 41 507	640 41 707
Dimension e	1000 mm	640 41 610	640 41 510	640 41 710
	1500 mm	640 41 615	640 41 515	640 41 715

* also available without mounting flange for portable application.

Part numbers for immersion length 400 to 4000 mm (in steps of 100 mm) on request.

Accessories:	Part No.
Suction strainer in polypropylene	001 10 235
Hose connection in polypropylene, complete with nut G 2 1/4 (BSP 2 1/4" female)	959 04 098
for hose inside diameter DN 32	959 04 099
for hose inside diameter DN 38	959 04 100

DRIVE MOTORS FOR CENTRIFUGAL IMMERSION PUMP F 640 PP

Three-phase motors protected to IP 55, with motor protection switch or cable terminal box

P 2	Capacity	Voltage	Frequency	Nominal speed	Part No.	Part No.
0,75 kW	230 / 400 V	50 Hz	2850 rpm	001 00 046	Version with motor protection switch	Version with cable terminal box
1,1 kW	230 / 400 V	50 Hz	2850 rpm	001 00 047	001 00 007	001 00 006
1,5 kW	230 / 400 V	50 Hz	2850 rpm	001 00 048	001 00 008	001 00 008
2,2 kW	230 / 400 V	50 Hz	2850 rpm	001 00 049	001 00 009	001 00 009
3,0 kW	400 V	50 Hz	2850 rpm	001 00 050	001 00 010	001 00 010
4,0 kW	400 V	50 Hz	2850 rpm	001 00 051	001 00 011	001 00 011

Three-phase motors explosion-proof to Ex e II T3 with cable terminal box

P 2	Capacity	Voltage	Frequency	Nominal speed	Part No.	Part No.
0,75 kW	230 / 400 V	50 Hz	2850 rpm	001 00 066	Version with cable terminal box	Motor protection switch Ex e de II C T6 to be mounted on the carrying handle
1,1 kW	230 / 400 V	50 Hz	2850 rpm	001 00 067	001 00 067	936 06 118
1,5 kW	230 / 400 V	50 Hz	2850 rpm	001 00 068	001 00 068	936 06 119
2,0 kW	230 / 400 V	50 Hz	2850 rpm	001 00 069	001 00 069	936 06 119
2,5 kW	400 V	50 Hz	2850 rpm	001 00 070	001 00 070	936 06 120
3,3 kW	400 V	50 Hz	2850 rpm	001 00 071	001 00 071	936 06 120

Accessories:	Part No.
Carrying handle for three-phase motors up to 3,0 kW	001 10 504
Carrying handle for three-phase motors up to 4,0 kW	001 10 531
Carrying handle for three-phase motors explosion-proof up to 3,3 kW	001 10 567

SCOPE OF SUPPLY

A complete vertical centrifugal immersion pump consists of: drive motor, pump and necessary accessories.

Weight per pump: 15 - 60 kg depending on the pump size, immersion length and motor kW.

CENTRIFUGAL IMMERSION PUMP F 640 PP

FLUX CENTRIFUGAL IMMERSION PUMP F 640 PP AND F 640 PVDF IN POLYPROPYLENE OR POLYVINYLIDENFLUORIDE SIZE 185

NEW



F 640 PP-185

Typical applications

Transferring low flammability liquids up to a viscosity of 2500 mPas (cP) from containers, tanks, either open topped or closed. Transferring corrosive liquids in chemical processing and engineering, melt-working and electroplating together with water treatment and waste water treatment. Suitable for stationary or portable application.

Construction features

Vertical centrifugal immersion pump for stationary application. The centrifugal impeller in the pump housing is driven by the motor via the drive shaft. The drive shaft is supported by intermediate bearings within the plastic sleeved steel inner tube, a mechanical seal separating the liquid from the bearings and upper shaft. This construction provides the ultimate in stability, preventing elongation of the plastic at high temperatures and ensures the maximum integrity of the mechanical seal.

This pump design does not have a separate discharge tube. Immediately after the pump housing the liquid is fed back into the outer tube and delivered to the outlet connection between the inner and outer tubes.

A range of carefully chosen impeller diameters, together with a range of three-phase motors in differing kW-ratings, ensures the optimum selection of pumps to meet the specific operating requirements. Connection of pump and motor is made via a flexible coupling.

CONSTRUCTION FEATURES IN DETAIL

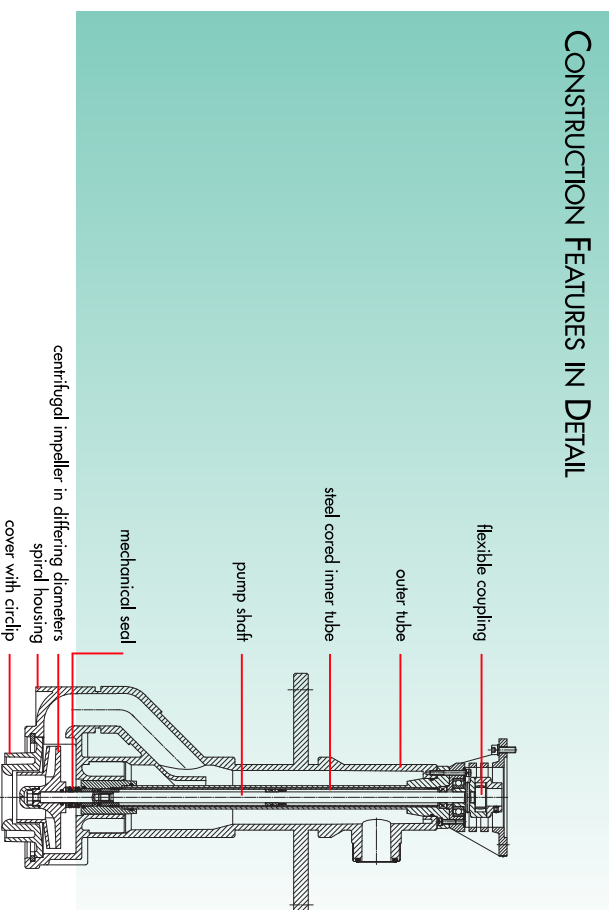

TECHNICAL DATA

Performance chart F 640 PP-185 and F 640 PVDF-185

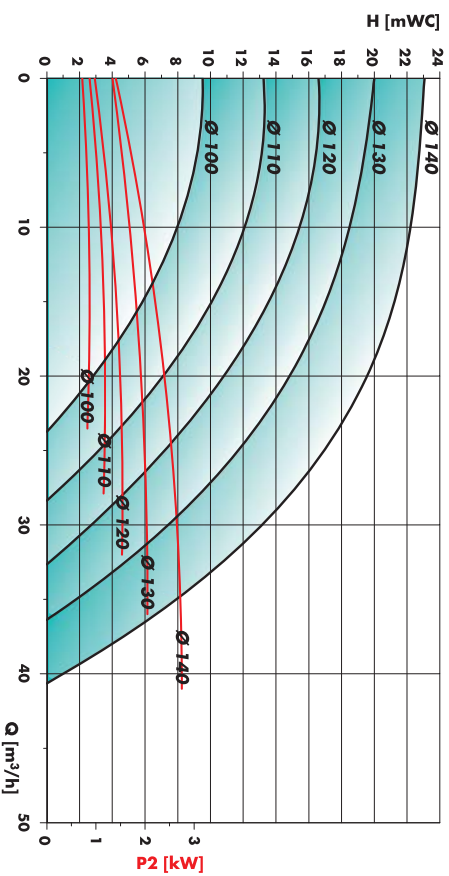

Measured values \pm 10% determined with water (20 °C) | Nominal speed $n = 2850 \text{ min}^{-1}$

In order to achieve the desired output, centrifugal impellers in diameters of 100 to 140 mm are available.

In determining the absorbed kW of the motor, multiply the absorbed kW shown in the above diagram with the specific gravity of the liquid to be pumped.

TECHNICAL DATA

Dimensions F 640 PP-185 and F 640 PVDF-185

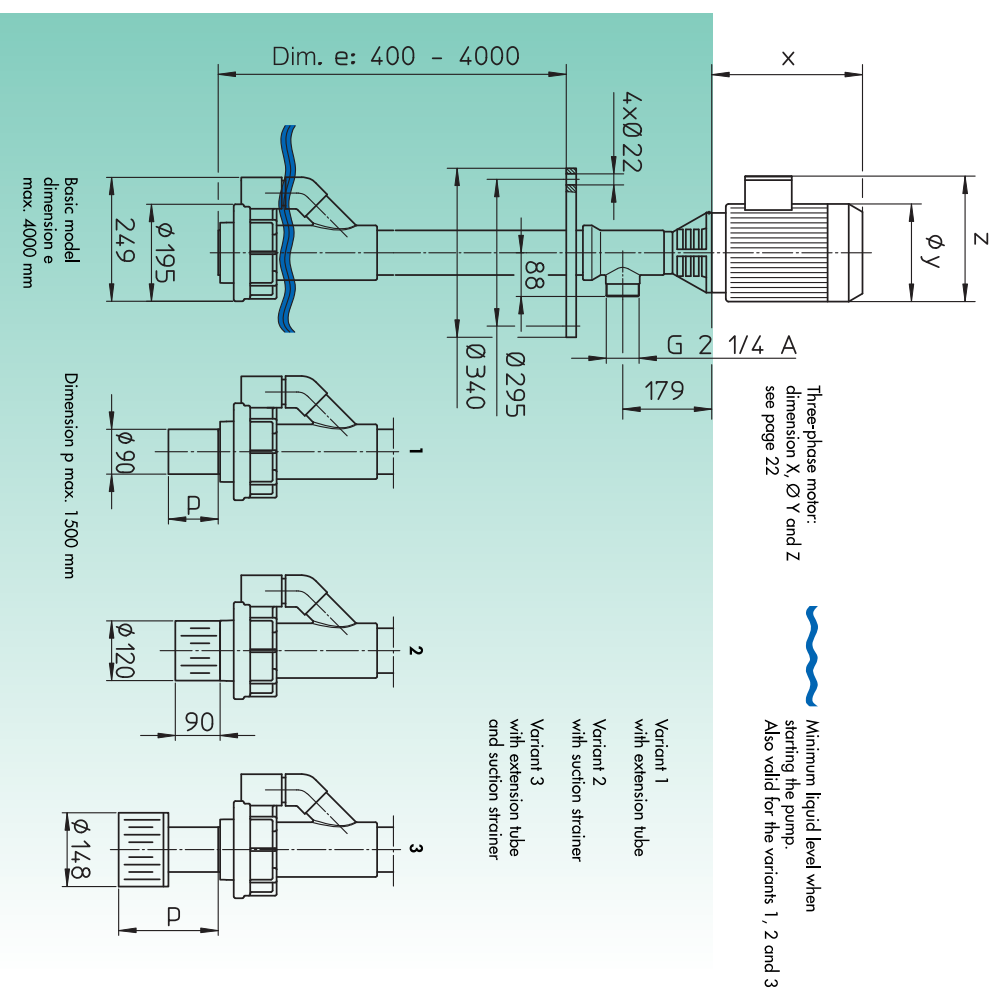

CENTRIFUGAL IMMERSION PUMP F 640 PP IN POLYPROPYLENE AND F 640 PVDF IN POLYVINYLIDENFLUORIDE, THREAD ON OUTLET G 2 1/4 A (BSP 2 1/4" MALE), WITHOUT DRIVE MOTOR

Type / Size	F 640 PP-185	F 640 PVDF-185
Delivery rate Q max.	40 m ³ /h	40 m ³ /h
Delivery head H max.	23 m water column	23 m water column
Viscosity max.	150 mPas (cP)	150 mPas (cP)
Temperature max.	60 °C	80 °C
Seal type		mechanical seal in ceramic oxide / SiC, o-rings in FPM
Material		shaft in Hastelloy C, seals in FPM
Centrifugal impeller		Ø 100 – 140 mm in PP or PVDF
Pump housing	Ø 249 mm	Ø 249 mm
Mounting flange		outside Ø 340 mm, pitch circle Ø 295 mm, 4 bores Ø 22 mm each
Part No.		
Immersion length	1000 mm	640 61 210
Dimension e	1500 mm	640 61 215
	2000 mm	640 61 220
Part numbers for immersion length 400 to 4000 mm (in steps of 100 mm) on request.		
Accessories:		Part No.
Extension tube in PP or PVDF in steps of 100 mm. Dimension p up to max. 1500 mm		
Suction strainer in PP or PVDF welded onto the cover of the pump housing or onto the extension tube		
Hose connection in polypropylene, complete with nut G 2 1/4" (BSP 2 1/4" female)	959 04 098	
for hose inside diameter DN 32	959 04 099	
for hose inside diameter DN 38	959 04 100	
for hose inside diameter DN 50		
Hose connection in polyvinylidene fluoride, complete with nut G 2 1/4" (BSP 2 1/4" female)	959 04 104	
for hose inside diameter DN 32	959 04 105	
for hose inside diameter DN 38	959 04 106	
for hose inside diameter DN 50	959 04 096	

DRIVE MOTORS FOR CENTRIFUGAL IMMERSION PUMPS F 640 PP AND F 640 PVDF

Three-phase motors protected to IP 55, with motor protection switch or cable terminal box

P 2	Capacity	Voltage	Frequency	Nominal speed	Part No.	Part No.
					Version with motor protection switch	Version with cable terminal box
0,75 kW	230 /400 V	50 Hz	2850 rpm	001 00 046	001 00 006	001 00 006
1,1 kW	230 /400 V	50 Hz	2850 rpm	001 00 047	001 00 007	001 00 007
1,5 kW	230 /400 V	50 Hz	2850 rpm	001 00 048	001 00 008	001 00 008
2,2 kW	230 /400 V	50 Hz	2850 rpm	001 00 049	001 00 009	001 00 009
3,0 kW	400 V	50 Hz	2850 rpm	001 00 050	001 00 010	001 00 010
4,0 kW	400 V	50 Hz	2850 rpm	001 00 051	001 00 011	001 00 011

Three-phase motors explosion-proof to Ex e II T3 with cable terminal box

P 2	Capacity	Voltage	Frequency	Nominal speed	Part No.	Part No.
					Version with cable terminal box	Motor protection switch Ex e II T3 to be mounted on the carrying handle
0,75 kW	230 /400 V	50 Hz	2850 rpm	001 00 066	936 06 118	936 06 118
1,1 kW	230 /400 V	50 Hz	2850 rpm	001 00 067	936 06 119	936 06 119
1,5 kW	230 /400 V	50 Hz	2850 rpm	001 00 068	936 06 119	936 06 119
2,0 kW	230 /400 V	50 Hz	2850 rpm	001 00 069	936 06 119	936 06 119
2,5 kW	400 V	50 Hz	2850 rpm	001 00 070	936 06 120	936 06 120
3,3 kW	400 V	50 Hz	2850 rpm	001 00 071	936 06 120	936 06 120

SCOPE OF SUPPLY

A complete vertical centrifugal immersion pump consists of: drive motor, pump with mounting flange and necessary accessories.

Weight per pump: 20 – 60 kg depending on the pump size, immersion length and motor kW.

CENTRIFUGAL IMMERSION PUMP F 640 PP AND F 640 PVDF

FLUX CENTRIFUGAL PUMPS F 620 S TR AND F 640 PP TR IN HORIZONTAL VERSION

Typical applications

Transferring low flammability liquids up to a viscosity of 2500 mPas (cP) from containers or tanks, either open topped or closed. The pump is used either horizontally mounted onto a base plate or fixed vertically.

Construction features

Centrifugal pump in horizontal version in stainless steel or polypropylene, consisting of an inner tube and outer tube.

The centrifugal impeller in the pump housing is driven by the motor via the drive shaft. The drive shaft is supported by intermediate bearings within inner tube, a mechanical seal separates the liquid from the bearings and upper shaft.

The PP version has a steel cored PP inner tube. This construction provides the ultimate in stability, preventing elongation of the plastic at high temperatures and ensures the maximum integrity of the mechanical seal.

With an open conical impeller or a closed centrifugal impeller (Z)

Depending on the model, suction and discharge sides are fitted with threaded or flanged connections.

Three-phase motors in differing kW-ratings are available as a matched power unit. Connection to the pump is made via a flexible coupling.



F 640 PP-30 TR mounted on base plate

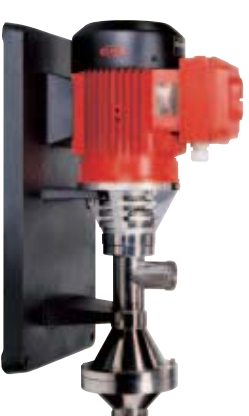

F 620 S-30 TR mounted on base plate



F 640 PP-230 TR mounted on base plate

TECHNICAL DATA

Performance chart F 620 S-30 TR,

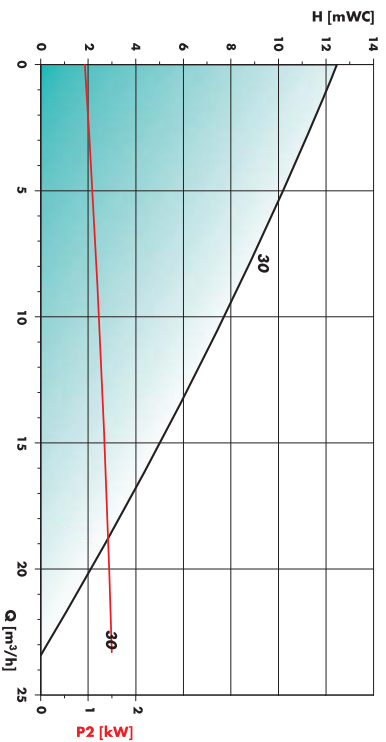

Performance chart F 640 PP-30 TR,

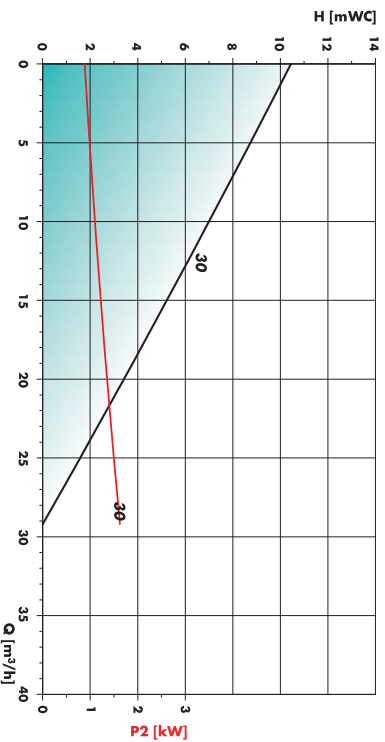

Performance chart F 640 PP-230 TR

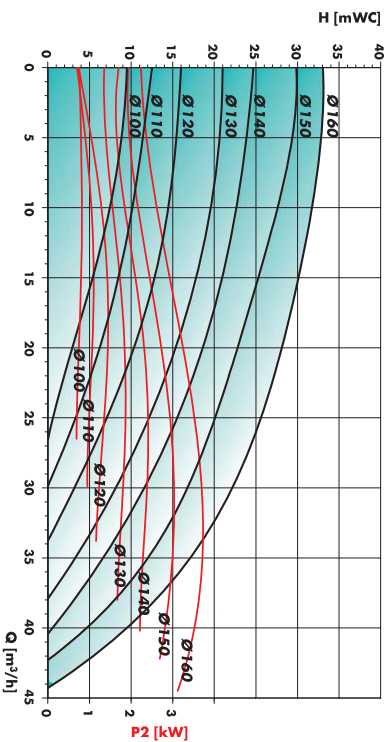

Measured values $\pm 10\%$ determined with water (20 °C). Nominal speed $n = 2850$ rpm

In determining the absorbed kW of the motor, multiply the absorbed kW shown in the above diagram with the specific gravity of the liquid to be pumped.

TECHNICAL DATA

Dimensions F 620 S-30 TR with thread connection

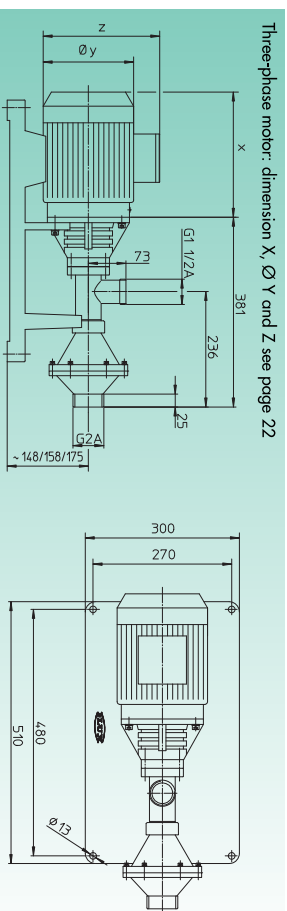

Three-phase motor: dimension X, \varnothing Y and Z see page 22

Dimensions F 640 PP-30 TR with thread connection

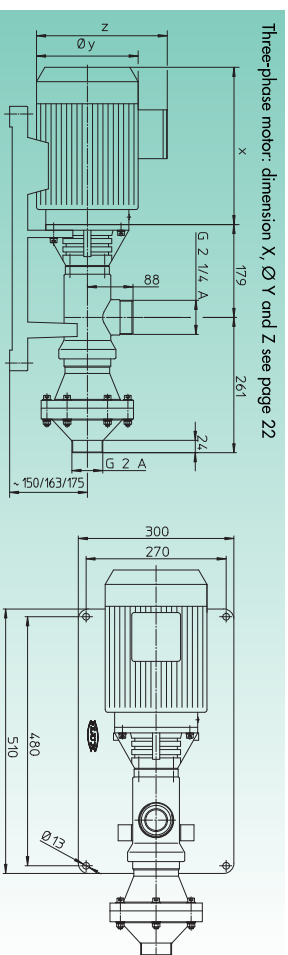

Three-phase motor: dimension X, \varnothing Y and Z see page 22

Dimensions F 640 PP-30 TR with flange connection

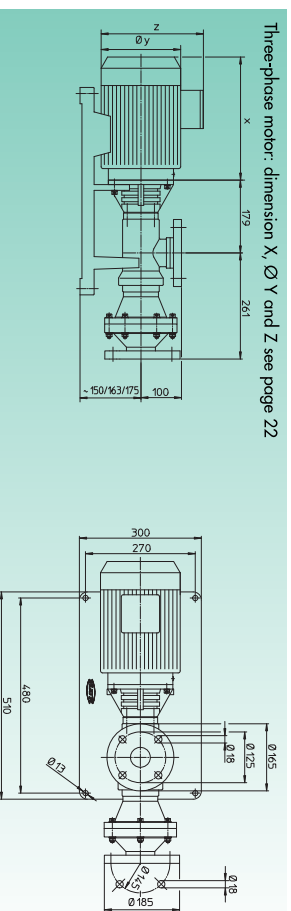

Three-phase motor: dimension X, \varnothing Y and Z see page 22

Dimensions F 640 PP-230 TR with flange connection

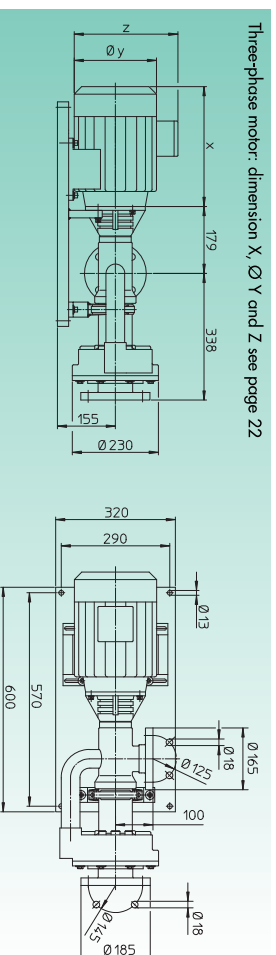

Three-phase motor: dimension X, \varnothing Y and Z see page 22

CENTRIFUGAL PUMP F 620 S TR IN STAINLESS STEEL, WITHOUT DRIVE MOTOR

Type / Size	F 620 S-30 TR
Delivery rate Q max.	23 m ³ /h
Delivery head H max.	12 m water column
Viscosity max.	2500 mPas (cP)
Temperature max.	100 °C
Seal type	mechanical seal in ceramic oxide, o-rings in FPM
Material	shaft in stainless steel 1.4571/316 Ti, seals in FPM
Impeller	open conical impeller in polypropylene (version in stainless steel on request)
Suction side	thread G 2 A (BSP 2" male)
Discharge side	thread G 1 1/2 A (BSP 1 1/2" male)
Part No.	620 25 502

Accessories:	Part No.
Base plate in aluminium alloy	001 15 002
Hose connection in stainless steel, complete with nut G 1 1/2" (BSP 1 1/2" female)	959 04 002
for hose inside diameter DN 25	959 04 003
for hose inside diameter DN 32	959 04 004
for hose inside diameter DN 38	

CENTRIFUGAL PUMP F 640 PP TR IN POLYPROPYLENE, WITHOUT DRIVE MOTOR

Type / Size	F 640 PP-30 TR
Delivery rate Q max.	29 m ³ /h
Delivery head H max.	10 m water column
Viscosity max.	2500 mPas (cP)
Temperature max.	50 °C
Seal type	mechanical seal in ceramic oxide /SiC, o-rings in FPM
Material	shaft in Hastelloy C, seals in FPM
Impeller	open conical impeller in PP
Suction side	thread G 2 A (BSP 2" male)
Discharge side	thread G 2 1/4 A (BSP 2 1/4" male)
Part No.	640 41 601
	640 41 600

CENTRIFUGAL PUMP F 640 PP TR IN POLYPROPYLENE, WITHOUT DRIVE MOTOR

Type / Size	F 640 PP-230 TR
Delivery rate Q max.	44 m ³ /h
Delivery head H max.	33 m water column
Viscosity max.	150 mPas (cP)
Temperature max.	60 °C
Seal material	mechanical seal in ceramic oxide/SiC, o-rings in FPM
Material	shaft in Hastelloy C, seals in FPM
Impeller	Ø 100 – 160 mm in PP
Suction side	flange DN 65, PN 10; outside Ø 185 mm, p.c.Ø 145 mm, 4 bores Ø 18 mm each
Discharge side	flange DN 50, PN 10; outside Ø 165 mm, p.c.Ø 125 mm, 4 bores Ø 18 mm each
Part No.	640 41 300

Accessories:	Part No.
Base plate in aluminium alloy for F 640 PP-30 TR	001 15 001
Base plate in polypropylene for F 640 PP-30 TR and F 640 PP-230 TR	001 15 023
Hose connection in polypropylene, complete with nut G 2 1/4" (BSP 2 1/4" female)	959 04 098
for hose inside diameter DN 32	959 04 099
for hose inside diameter DN 38	959 04 100
for hose inside diameter DN 50	

Drive motors see page 9

SCOPE OF SUPPLY

A complete centrifugal pump in horizontal version consists of drive motor, pump and base plate. Weight per pump including base plate: 9 – 50 kg depending on pump size and motor kW.

CENTRIFUGAL PUMPS IN HORIZONTAL VERSION

FLUX CENTRIFUGAL IMMERSION PUMP F 706 PP IN POLYPROPYLENE SIZE 135, 185, 230 AND 350

Typical applications

Transfer of corrosive liquids in the chemical industry and all aspects of chemical engineering together with any application that requires the safe and economical transfer, or circulation, of acids and alkalis or other chemical fluids, with or without solids in suspension.

Construction features

Vertical centrifugal immersion pump for stationary application. The robust pump housing is solidly welded to the support tube. A sleeve bearing, which is lubricated by the liquid, allows immersion lengths of up to 1000 mm, and on the pump size 230, with additional intermediate bearings, even up to 2000 mm. A large polypropylene-coated drive shaft together with the use of a thick-walled support tube ensures a very smooth running pump. This type of construction prevents the rotating components from coming to contact with the pump housing and guarantees a long service life and extended maintenance intervals, even in the case of continuous use.

A range of carefully chosen impeller diameters, together with a range of three-phase motors in differing kW-ratings, ensures the optimum selection of pumps to meet the specific operating requirements. Connection of pump and motor is made via a flexible coupling.



F 706 PP-330

CONSTRUCTION FEATURES IN DETAIL

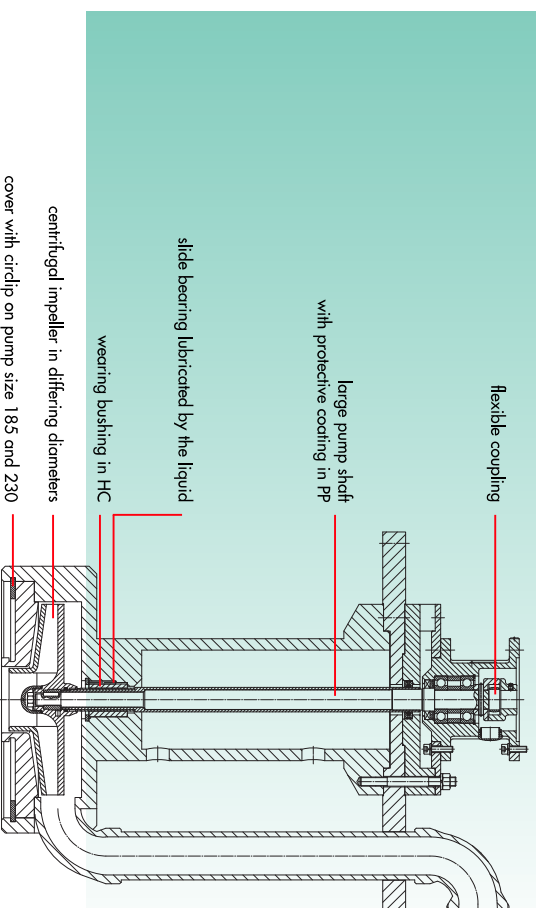

TECHNICAL DATA

Performance chart F 706 PP-135

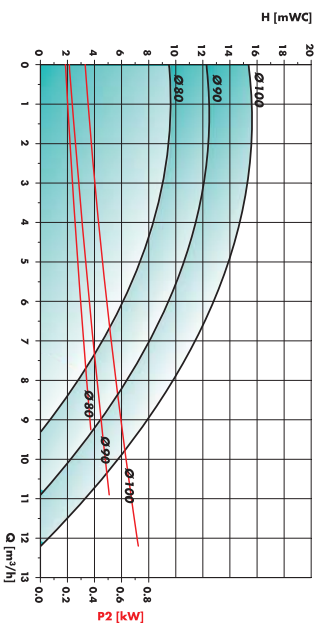

Measured values
± 10% determined with water (20 °C),
Nominal speed n = 2850 rpm

In order to obtain the desired output, centrifugal impellers in differing diameters are available.

In determining the absorbed kW of the motor, multiply the absorbed kW shown in the above diagram with the specific gravity of the liquid to be pumped.

Performance chart F 706 PP-185

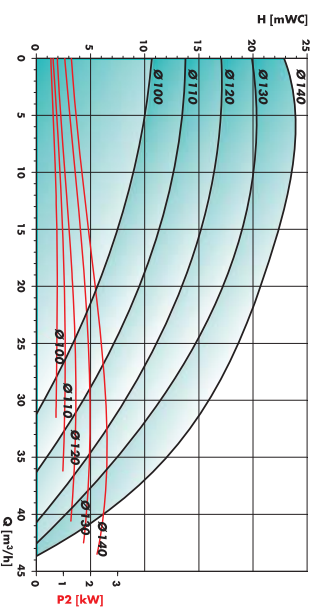

Performance chart F 706 PP-230

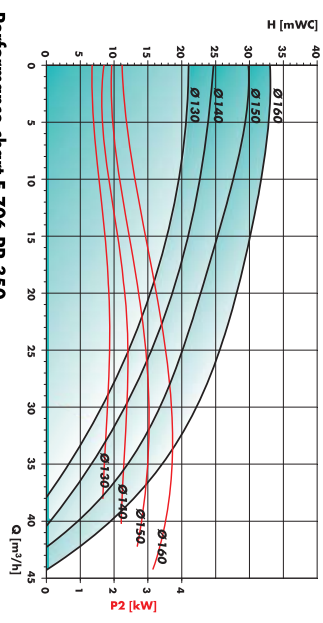

Performance chart F 706 PP-350

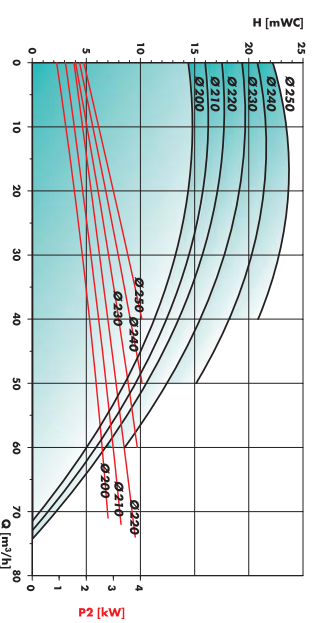

Nominal speed n = 1450 rpm

TECHNICAL DATA

Dimensions F 706 PP-135

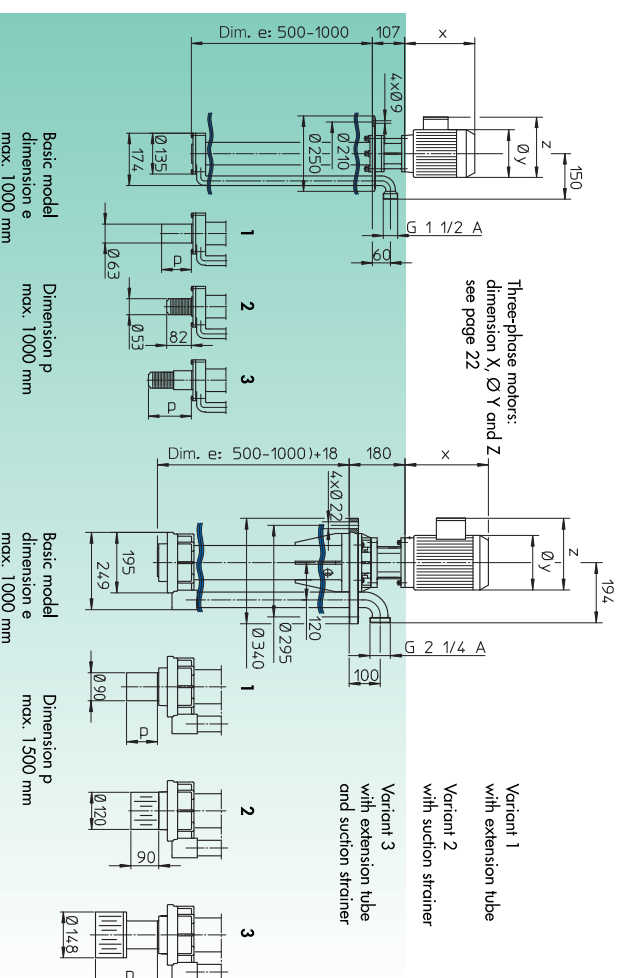

Dimensions F 706 PP-185

Dimensions F 706 PP-230

Three-phase motors:
dimension X, Ø Y and Z
see page 22

Dimensions F 706 PP-350

Minimum or maximum liquid level when starting the pump.
Also valid for the variants 1, 2 and 3

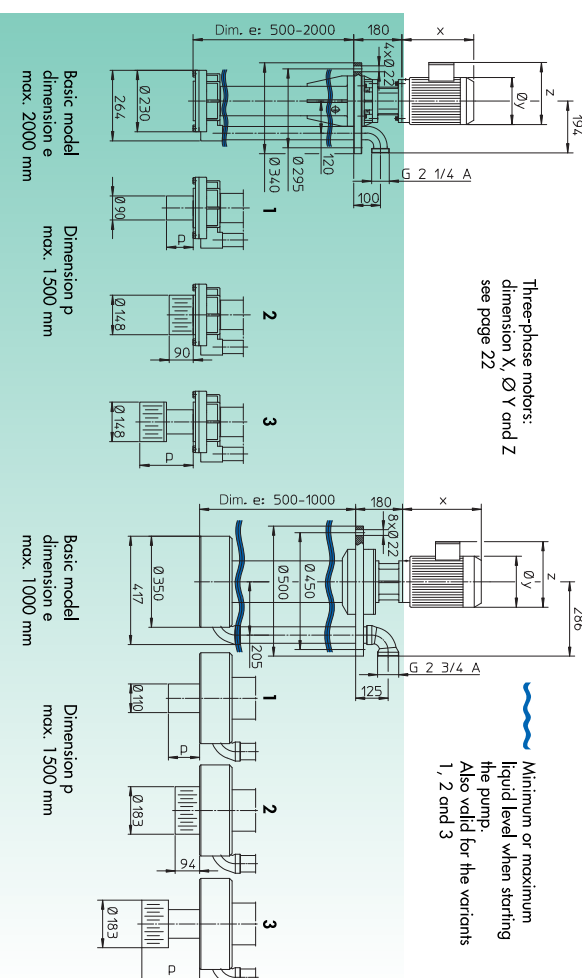

CENTRIFUGAL IMMERSION PUMP F 706 PP IN POLYPROPYLENE, VERSION WITH SUPPORT TUBE, WITHOUT DRIVE MOTOR

Type / Size	F 706 PP-135	F 706 PP-185	F 706 PP-230	F 706 PP-350
Delivery rate Q max.	12 m³/h	43 m³/h	44 m³/h	74 m³/h
Delivery head H max.	15 m water column	23 m water column	33 m water column	23 m water column
Viscosity max.	150 mPas (cP)	150 mPas (cP)	150 mPas (cP)	150 mPas (cP)
Temperature max.	60 °C	60 °C	60 °C	60 °C
Seal material	no seals in contact with the liquid			
Material	shaft in stainless steel 1.4571/316 Ti with protective coating in PP slide bearing in hard carbon or fluorosint			
Centrifugal Impeller in PP	Ø 80 – 100 mm	Ø 100 – 140 mm	Ø 130 – 160 mm	Ø 200 – 250 mm
Pump housing	Ø 174 mm	Ø 249 mm	Ø 264 mm	Ø 417 mm
Mounting flange in PP	outside Ø 250 mm	outside Ø 340 mm	outside Ø 340 mm	outside Ø 500 mm
Thread on outlet	G 1/2 A (BSP 1 1/2" male)	G 2/1 A (BSP 2 1/4" male)	G 2/1 A (BSP 2 1/4" male)	G 2 1/4 A (BSP 2 3/4" male)
Motor capacity P 2	0,37 – 0,75 kW n = 2850 rpm	1,5 – 4,0 kW n = 2850 rpm	3,0 – 5,5 kW n = 2850 rpm	3,0 – 5,5 kW n = 1450 rpm
Part No.	706 41 105	706 41 205	706 41 305	706 41 405
Immersion length	700 mm	706 41 107	706 41 207	706 41 407
Dimension e	1000 mm	706 41 110	706 41 210	706 41 310
				706 41 410

Accessories:

Extension tube in PP in steps of 100 mm.
Dimension p up to max. 1000 mm at size 135 and up to 1500 mm at sizes 185, 230 and 350.

Suction strainer in PP welded onto the cover of the pump housing or onto the extension tube.

DRIVE MOTORS FOR CENTRIFUGAL IMMERSION PUMP F 706 PP

Three-phase motors protected to IP 55, with cable terminable box

Capacity P 2	Flange Ø	Voltage	Frequency	Nominal speed	Part No.
0,37 kW	120 mm	230/400 V	50 Hz	n = 2850 rpm	001 00 004
0,55 kW	120 mm	230/400 V	50 Hz	n = 2850 rpm	001 00 005
0,75 kW	120 mm	230/400 V	50 Hz	n = 2850 rpm	001 00 019
1,5 kW	160 mm	230/400 V	50 Hz	n = 2850 rpm	001 00 008
2,2 kW	160 mm	230/400 V	50 Hz	n = 2850 rpm	001 00 009
3,0 kW	160 mm	400 V	50 Hz	n = 2850 rpm	001 00 010
4,0 kW	160 mm	400 V	50 Hz	n = 2850 rpm	001 00 011
5,5 kW	160 mm	400 V	50 Hz	n = 2850 rpm	001 00 015
3,0 kW	160 mm	400 V	50 Hz	n = 1450 rpm	001 00 530
4,0 kW	160 mm	400 V	50 Hz	n = 1450 rpm	001 00 511
5,5 kW	160 mm	400 V	50 Hz	n = 1450 rpm	001 00 532

Three-phase motors explosion-proof to Ex e II T3 with terminal box on request.

SCOPE OF SUPPLY

A complete vertical centrifugal immersion pump consists of: drive motor, pump with mounting flange and necessary accessories.
Weight per pump F 706 PP: 1,3 – 85 kg depending on the pump size, immersion length and motor kW.

CENTRIFUGAL IMMERSION PUMP F 706 PP

FLUX CENTRIFUGAL IMMERSION PUMP F 716 PP AND F 716 PVDF IN POLYPROPYLENE OR POLYVINYLIDENFLUORIDE SIZE 115 AND 135

Typical applications

Transferring and circulating of neutral or corrosive liquids in the chemical industry and chemical engineering, electroplating industry, steel or stainless steel pickling plants, flue gas decontamination, exhaust air purification, water and waste water treatment.

Construction features

Vertical centrifugal immersion pump for stationary application. With a compact design requiring very little head room above the mounting flange. This design uses a three-phase motor with extended shaft, especially allowing the pump to use the motor shaft. All wetted parts are made in PP or PVDF. The robust support tube (bars) solidly connected to the mounting flange ensures a very smooth running, prevents the rotating elements from making contact with the pump housing and guarantees a very long service life, even in case of continuous use. As neither bearings nor seals are in contact with the liquid, the pump is very wear-resistant and suitable for dry running operation.

The immersion length of the pump can be extended, up to 1000 mm maximum, by the suction tube option. A suction strainer welded onto the cover of the pump housing or onto the extension tube protects the pump against the ingress of coarse impurities.

A range of carefully chosen impeller diameters, together with a range of three-phase motors in differing kW-ratings, ensures the optimum selection of pumps to meet the specific operating requirements.

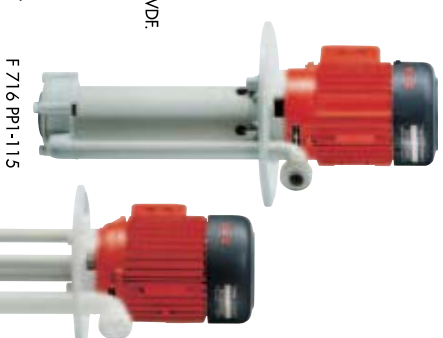

F 716 PVDF-135

CONSTRUCTION FEATURES IN DETAIL

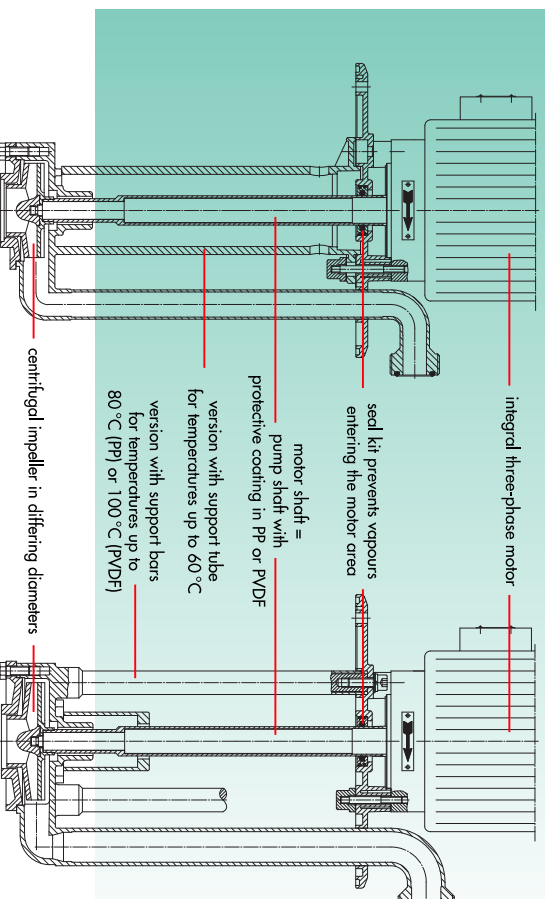

- integral three-phase motor
- seal kit prevents vapours entering the motor area
- motor shaft = pump shaft with protective coating in PP or PVDF
- version with support tube for temperatures up to 60 °C
- version with support bars for temperatures up to 80 °C (PP) or 100 °C (PVDF)
- centrifugal impeller in differing diameters

TECHNICAL DATA

Performance chart F 716 PP1-115, F 716 PP2-115 and F 716 PVDf2-115

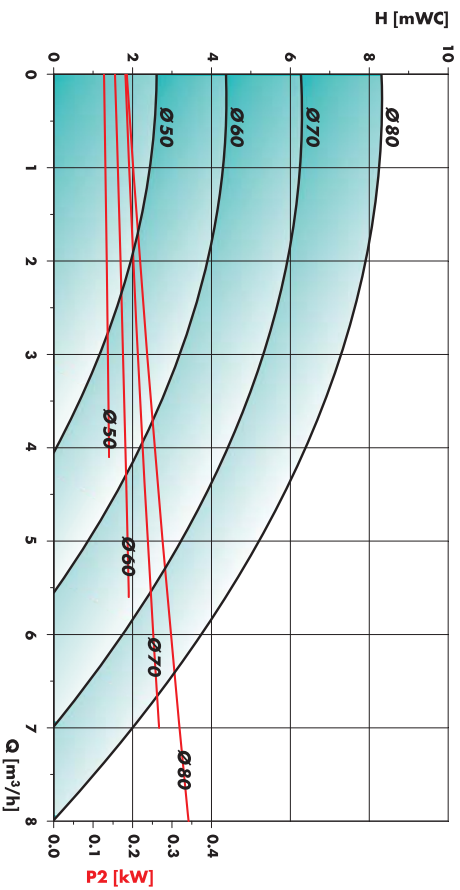

Measured values \pm 10% determined with water (20 °C). Nominal speed $n = 2850$ rpm

In order to obtain the desired output, centrifugal impellers in differing diameters are available.

In determining the absorbed kW of the motor, multiply the absorbed kW shown in the above diagram with the specific gravity of the liquid to be pumped.

Performance chart F 716 PP1-135, F 716 PP2-135 and F 716 PVDf2-135

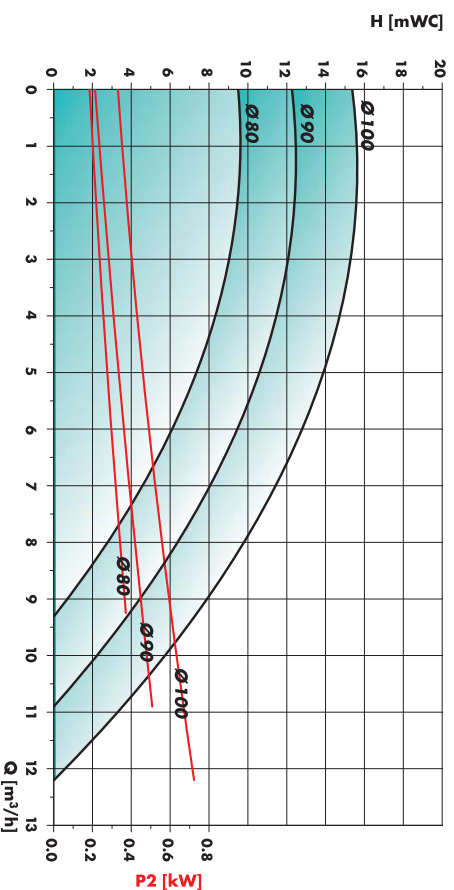

TECHNICAL DATA

Dimensions F 716 PP1-115

Version with support tube

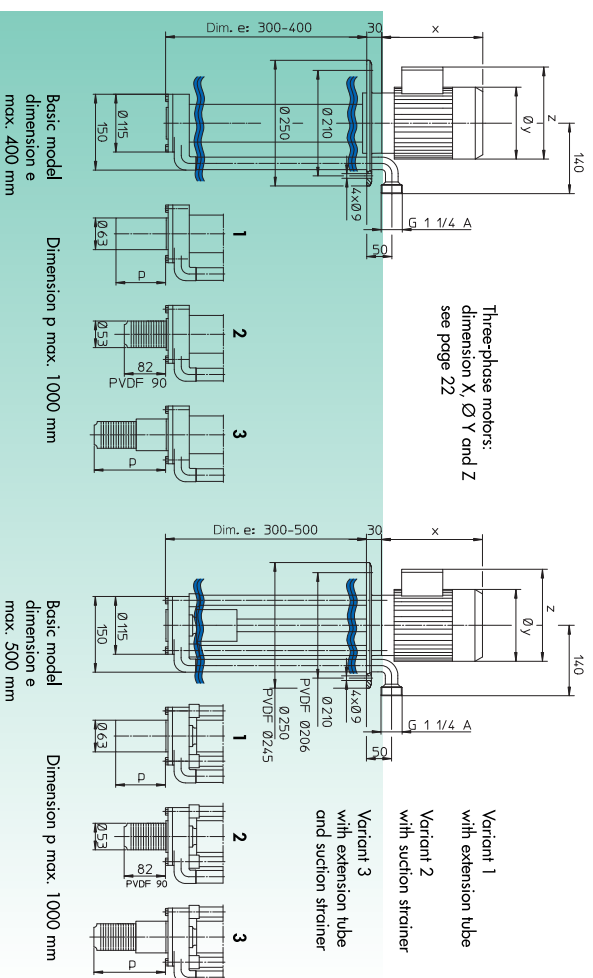

Basic model dimension e max. 400 mm

Dimension p max. 1000 mm

Basic model dimension e max. 500 mm

Dimension p max. 1000 mm

Dimensions F 716 PP2-115 and F 716 PVDf2-115

Version with support bars

Dimensions F 716 PP1-135

Version with support tube

Dimensions F 716 PP2-135 and F 716 PVDf2-135

Version with support bars

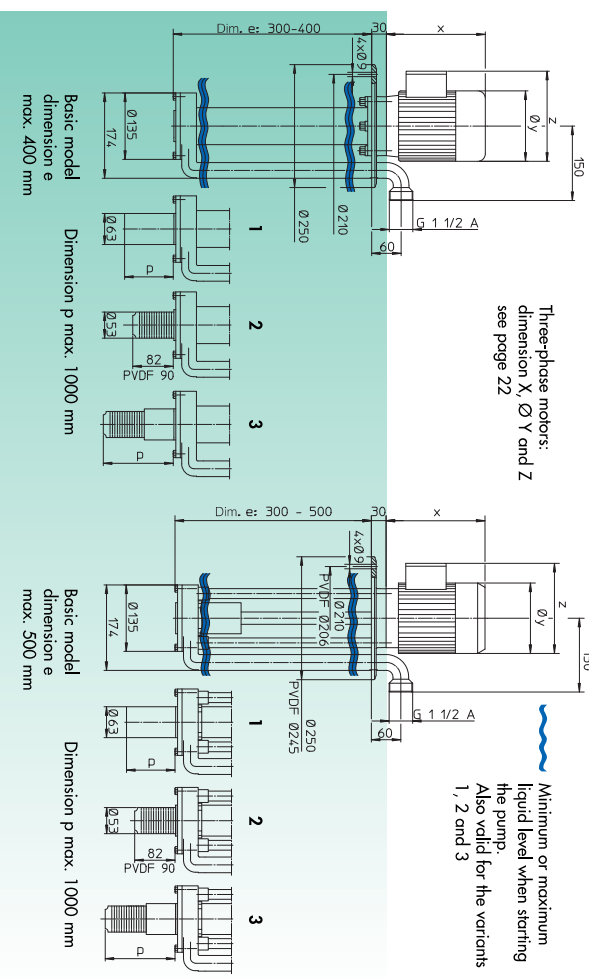

Basic model dimension e max. 400 mm

Dimension p max. 1000 mm

Basic model dimension e max. 500 mm

Dimension p max. 1000 mm

CENTRIFUGAL IMMERSION PUMP F 716 PP IN POLYPROPYLENE, WITH INTEGRAL THREE-PHASE MOTOR

Type / Size	F 716 PP1-115	F 716 PP2-115	F 716 PP1-135	F 716 PP2-135
Version	with support tube	with support bars	with support tube	with support bars
Delivery rate Q max.	8 m ³ /h	8 m ³ /h	12 m ³ /h	12 m ³ /h
Delivery head H max.	8 m water column	8 m water column	15 m water column	15 m water column
Viscosity max.	150 mPas (cP)	150 mPas (cP)	150 mPas (cP)	150 mPas (cP)
Temperature max.	60 °C	80 °C	60 °C	80 °C
Seal material		no bearings nor seals in contact with the liquid		
Material		shaft in stainless steel 1.4571/316 Ti with protective coating in PP		
Centrifugal impeller in PP	Ø 50 – 80 mm	Ø 50 – 80 mm	Ø 80 – 100 mm	Ø 80 – 100 mm
Pump housing	Ø 150 mm	Ø 150 mm	Ø 174 mm	Ø 174 mm
Mounting flange in PP	outside Ø 250 mm	outside Ø 250 mm	outside Ø 250 mm	outside Ø 250 mm
Thread on outlet	G 1/4 A (BSP 1/4" male)	G 1/4 A (BSP 1/4" male)	G 1/2 A (BSP 1/2" male)	G 1/2 A (BSP 1/2" male)
Part No.				
Motor capacity P2	0,37 kW	0,37 kW	0,37 kW	0,37 kW
Immersion length	300 mm	716 41 003	716 41 103	716 42 103
Dimension e	400 mm	716 41 004	716 41 104	716 42 104
	500 mm	-	-	716 42 105
Part No.				
Motor capacity P2	0,55 kW	0,55 kW	0,55 kW	0,55 kW
Immersion length	300 mm	716 41 013	716 41 113	716 42 113
Dimension e	400 mm	716 41 014	716 41 114	716 42 114
	500 mm	-	-	716 42 115
Part No.				
Motor capacity P2	0,75 kW	0,75 kW	0,75 kW	0,75 kW
Immersion length	300 mm	-	716 41 123	716 42 123
Dimension e	400 mm	-	716 41 124	716 42 124
	500 mm	-	-	716 42 125

CENTRIFUGAL IMMERSION PUMP F 716 PVDF IN POLYVINYLIDENFLUORIDE, WITH INTEGRAL THREE-PHASE MOTOR

Type / Size	F 716 PVDF2-115	F 716 PVDF2-135
Version	with support bars	with support bars
Delivery rate Q max.	8 m ³ /h	12 m ³ /h
Delivery head H max.	8 m water column	15 m water column
Viscosity max.	150 mPas (cP)	150 mPas (cP)
Temperature max.	100 °C	100 °C
Seal material		no bearings nor seals in contact with the liquid
Material		shaft in stainless steel 1.4571/316 Ti with protective coating in PVDF
Centrifugal impeller in PVDF	Ø 50 – 80 mm	Ø 80 – 100 mm
Pump housing	Ø 150 mm	Ø 174 mm
Mounting flange in PVDF	outside Ø 245 mm	outside Ø 245 mm
Thread on outlet	G 1/4 A (BSP 1/4" male)	G 1/2 A (BSP 1/2" male)
Part No.		
Motor capacity P2	0,37 kW	0,37 kW
Immersion length	300 mm	716 62 003
Dimension e	400 mm	716 62 004
	500 mm	716 62 005
Part No.		
Motor capacity P2	0,55 kW	0,55 kW
Immersion length	300 mm	716 62 013
Dimension e	400 mm	716 62 014
	500 mm	716 62 015
Part No.		
Motor capacity P2	0,37 kW	0,55 kW
Immersion length	300 mm	716 62 103
Dimension e	400 mm	716 62 104
	500 mm	716 62 105
Part No.		
Motor capacity P2	0,55 kW	0,75 kW
Immersion length	300 mm	716 62 113
Dimension e	400 mm	716 62 114
	500 mm	716 62 115
Part No.		
Motor capacity P2	0,37 kW	0,55 kW
Immersion length	300 mm	716 62 103
Dimension e	400 mm	716 62 104
	500 mm	716 62 105
Part No.		
Motor capacity P2	0,55 kW	0,75 kW
Immersion length	300 mm	716 62 113
Dimension e	400 mm	716 62 114
	500 mm	716 62 115

Accessories:
Extension tube in PP or PVDF in steps of 100 mm. Dimension p up to max. 1000 mm.
Suction strainer in PP or PVDF welded at the cover of the pump housing or at the extension tube.

SCOPE OF SUPPLY

A complete vertical centrifugal immersion pump consists of pump with mounting flange and integral three-phase motor and necessary accessories. Weight per pump: 9 – 15 kg depending on the pump size, immersion length and motor kW.

CENTRIFUGAL IMMERSION PUMP F 716 PP AND F 716 PVDF

FLUX CENTRIFUGAL IMMERSION PUMP F 716 PP AND F 716 PVDF IN POLYPROPYLENE OR POLYVINYLIDENFLUORIDE SIZE 185 AND 230

Typical applications

Transferring and circulating of neutral or corrosive liquids in the chemical industry and chemical engineering, electroplating industry, steel or stainless steel pickling plants, flue gas decontamination, exhaust air purification, water and waste water treatment.

Construction features

Vertical centrifugal immersion pump for stationary application.

With a compact design requiring very little head room above the mounting flange. This design uses a three-phase motor with extended shaft, allowing the pump to use the motor shaft. All wetted parts are made in PP or PVDF.

The robust support tube (bars) solidly connected to the mounting flange ensures a very smooth running, prevents the rotating elements from making contact with the pump housing and guarantees a very long service life, even in case of continuous use.

As neither bearings nor seals are in contact with the liquid, the pump is very wear-resistant and suitable for dry running operation.

The immersion length of the pump can be extended, up to 1500 mm maximum, by the suction tube option. A suction strainer welded onto the cover of the pump housing or onto the extension tube protects the pump against the ingress of coarse impurities.

A range of carefully chosen impeller diameters, together with a range of three-phase motors in differing kW-ratings, ensures the optimum selection of pumps to meet the specific operating requirements.

F 716 PVDF2-230

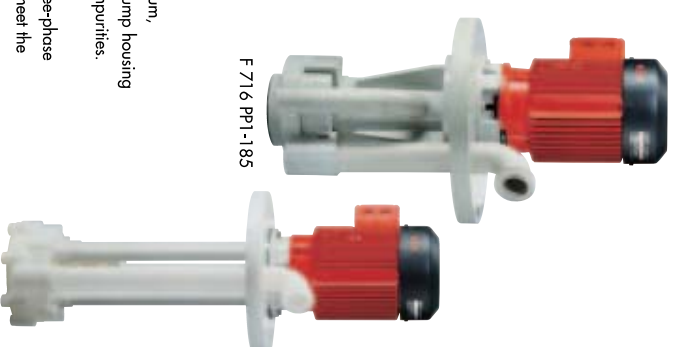

CONSTRUCTION FEATURES IN DETAIL

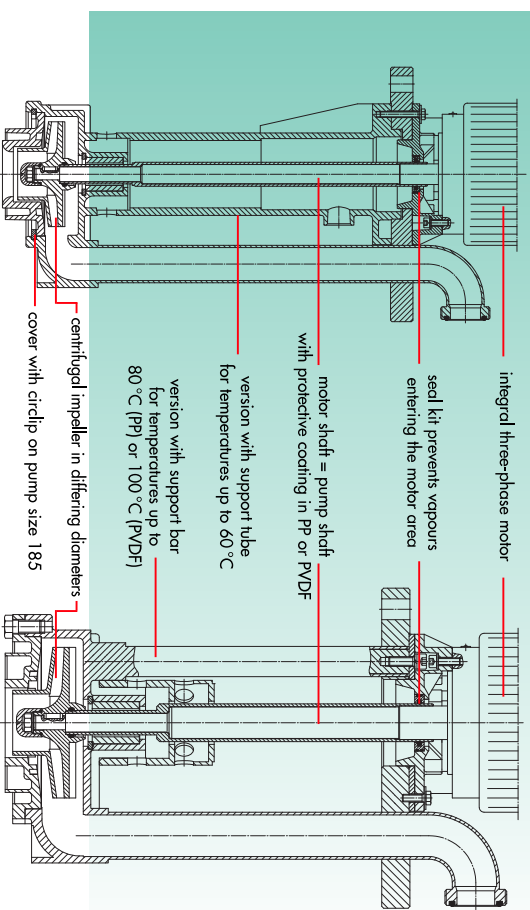

TECHNICAL DATA

Performance chart F 716 PP1-85, F 716 PP2-185 and F 716 PVDf2-185

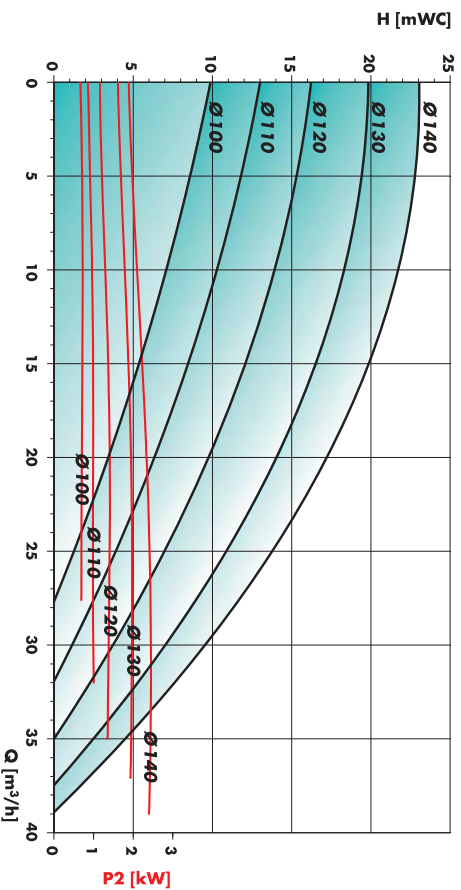

Measured values $\pm 10\%$ determined with water (20 °C). Nominal speed $n = 2850 \text{ min}^{-1}$

In order to obtain the desired output, centrifugal impellers in differing diameters are available.

In determining the absorbed kW of the motor, multiply the absorbed kW shown in the above diagram with the specific gravity of the liquid to be pumped.

Performance chart F 716 PP1-230, F 716 PP2-230 and F 716 PVDf2-230

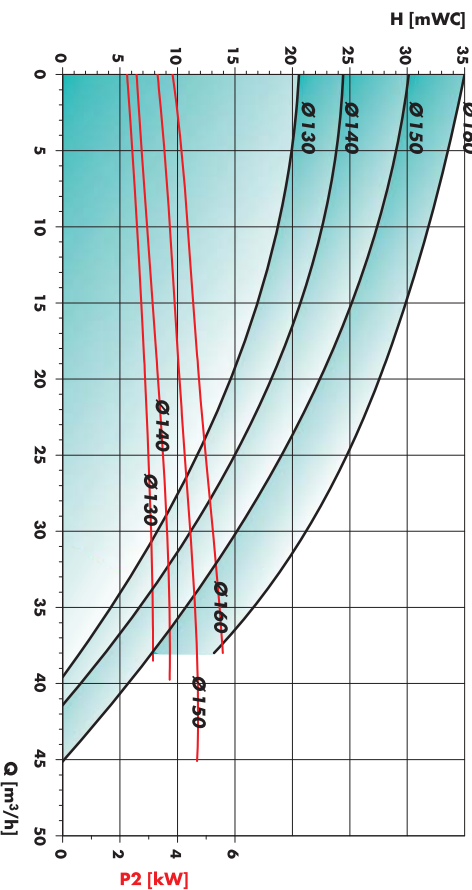

TECHNICAL DATA

Dimensions F 716 PP1-185

Version with support tube

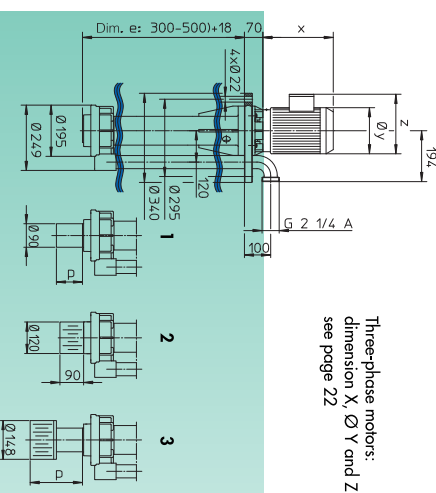

Three-phase motors:
dimension X, Ø Y and Z
see page 22

Basic model
dimension e
max. 500 mm

Dimension p max. 1500 mm

Dimensions F 716 PP2-185 and F 716 PVDf2-185

Version with support bars

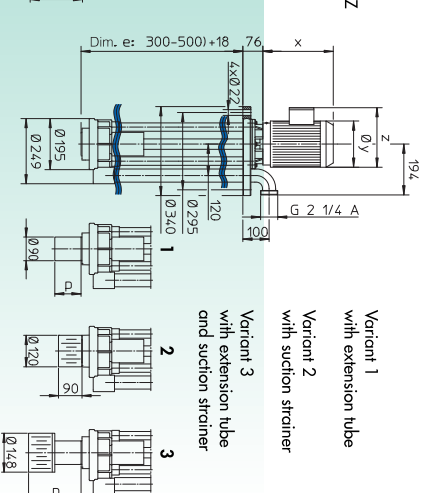

Variant 1
with extension tube
Variant 2
with suction strainer
Variant 3
with extension tube
and suction strainer

Basic model
dimension e
max. 500 mm

Dimension p max. 1500 mm

Dimensions F 716 PP1-230

Version with support tube

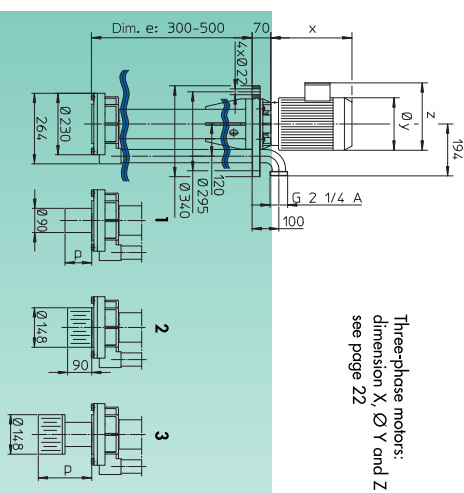

Three-phase motors:
dimension X, Ø Y and Z
see page 22

Basic model
dimension e
max. 500 mm

Dimension p max. 1500 mm

Dimensions F 716 PP2-230 and F 716 PVDf2-230

Version with support bars

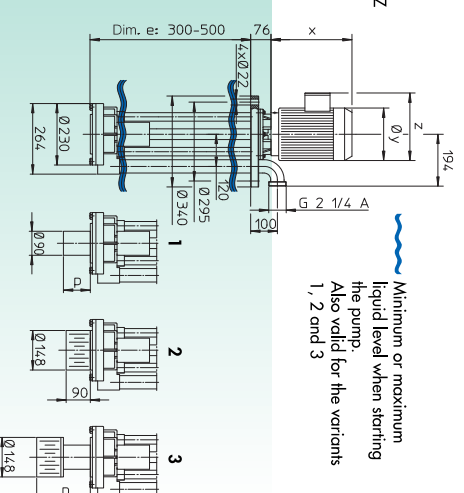

Minimum or maximum
liquid level when starting
the pump.
Also valid for the variants
1, 2 and 3

Basic model
dimension e
max. 500 mm

Dimension p max. 1500 mm

CENTRIFUGAL IMMERSION PUMP F 716 PP IN POLYPROPYLENE, WITH INTEGRAL THREE-PHASE MOTOR

Type / Size	F 716 PP2-185	F 716 PP2-185	F 716 PP1-230	F 716 PP2-230
Version	with support tube	with support bars	with support tube	with support bars
Delivery rate Q max.	38 m ³ /h	38 m ³ /h	45 m ³ /h	45 m ³ /h
Delivery head H max.	23 m water column	23 m water column	35 m water column	35 m water column
Viscosity max.	150 mPas (cP)	150 mPas (cP)	150 mPas (cP)	150 mPas (cP)
Temperature max.	60 °C	80 °C	60 °C	80 °C
Seal material		no bearings nor seals in contact with the liquid		
Material		shaft in stainless steel 1.4571/316 Ti with protective coating in PP		
Centrifugal impeller in PP	Ø 100 – 140 mm	Ø 100 – 140 mm	Ø 130 – 160 mm	Ø 130 – 160 mm
Pump housing	Ø 249 mm	Ø 249 mm	Ø 264 mm	Ø 264 mm
Mounting flange in PP	outside Ø 340 mm	outside Ø 340 mm	outside Ø 340 mm	outside Ø 340 mm
Thread on outlet	G 2/1 A (BSP 2/1/8" male)	G 2/1 A (BSP 2/1/8" male)	G 2/1 A (BSP 2/1/8" male)	G 2/1 A (BSP 2/1/8" male)
Part No.				
Motor capacity P2	1,5 kW	1,5 kW	3,0 kW	3,0 kW
Immersion length	300 mm	300 mm	300 mm	300 mm
Dimension e	400 mm	400 mm	400 mm	400 mm
Motor capacity P2	2,2 kW	2,2 kW	4,0 kW	4,0 kW
Immersion length	300 mm	300 mm	300 mm	300 mm
Dimension e	400 mm	400 mm	400 mm	400 mm
Motor capacity P2	3,0 kW	3,0 kW	5,5 kW	5,5 kW
Immersion length	300 mm	300 mm	300 mm	300 mm
Dimension e	400 mm	400 mm	400 mm	400 mm
Motor capacity P2	4,0 kW	4,0 kW		
Immersion length	300 mm	300 mm		
Dimension e	400 mm	400 mm		

CENTRIFUGAL IMMERSION PUMP F 716 PVDF IN POLYVINYLIDENFLUORIDE, WITH INTEGRAL THREE-PHASE MOTOR

Type / Size	F 716 PVDF2-185	F 716 PVDF2-230
Version	with support bars	with support bars
Delivery rate Q max.	38 m ³ /h	45 m ³ /h
Delivery head H max.	23 m water column	35 m water column
Viscosity max.	150 mPas (cP)	150 mPas (cP)
Temperature max.	100 °C	100 °C
Seal material		no bearings nor seals in contact with the liquid
Material		shaft in stainless steel 1.4571/316 Ti with protective coating in PVDF
Centrifugal impeller in PVDF	Ø 100 – 140 mm	Ø 130 – 160 mm
Pump housing	Ø 249 mm	Ø 264 mm
Mounting flange in RGH1000	outer Ø 340 mm	outer Ø 340 mm
Thread on outlet	G 2/1 A	G 2/1 A
Part No.		
Motor capacity P2	1,5 kW	2,2 kW
Immersion length	300 mm	300 mm
Dimension e	400 mm	400 mm
Motor capacity P2	3,0 kW	4,0 kW
Immersion length	300 mm	300 mm
Dimension e	400 mm	400 mm
Motor capacity P2	4,0 kW	5,5 kW
Immersion length	300 mm	300 mm
Dimension e	400 mm	400 mm

Accessories:

Extension tube in PP or PVDF in steps of 100 mm. Dimension p up to max. 1500 mm.

Suction strainer in PP or PVDF welded onto the cover of the pump housing or onto the extension tube.

Weight per pump: 22 – 50 kg depending on the pump size, immersion length and motor kW.

17 CENTRIFUGAL IMMERSION PUMP F 716 PP AND F 716 PVDF

FLUX CENTRIFUGAL IMMERSION PUMP F 726 PP AND F 726 PVDF IN POLYPROPYLENE OR POLYVINYLIDENFLUORIDE SIZE 115 AND 135

Typical applications

Transferring and circulating of neutral or corrosive liquids in the whole field of the chemical industry and chemical engineering, electroplating industry, steel or stainless steel pickling plants, flue gas decontamination, exhaust air purification, water and waste-water treatment.

Construction features

Vertical centrifugal immersion pump for stationary application. The robust pump shaft is mounted in an upper pedestal and supported by two antifriction bearings. This construction, with the bearings spaced along the pedestal, ensures that any radial or axial forces are absorbed, even under heavy load. The result is a very smooth running pump. The solid version with support bars prevents the rotating elements from making contact with the pump housing and guarantees a very long service life, even in continuous use applications. As neither bearing nor seals are in contact with the liquid, the pump is very wear-resistant and suitable for dry running operation. The immersion length of the pump can be extended, up to 1000 mm maximum, by the suction tube option. A suction strainer welded onto the cover of the pump housing or onto the extension tube protects the pump against the ingress of coarse impurities.

A range of carefully chosen impeller diameters, together with a range of three-phase motors in differing kW-ratings, ensures the optimum selection of pumps to meet the specific operating requirements.

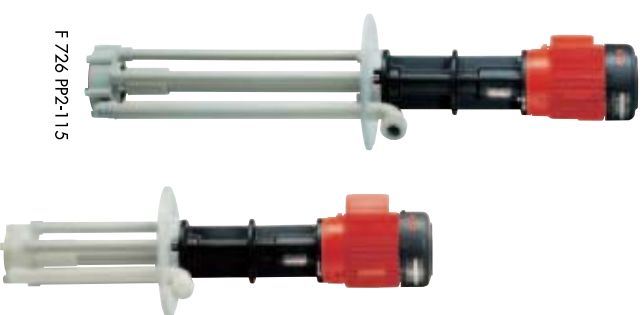

CONSTRUCTION FEATURES IN DETAIL

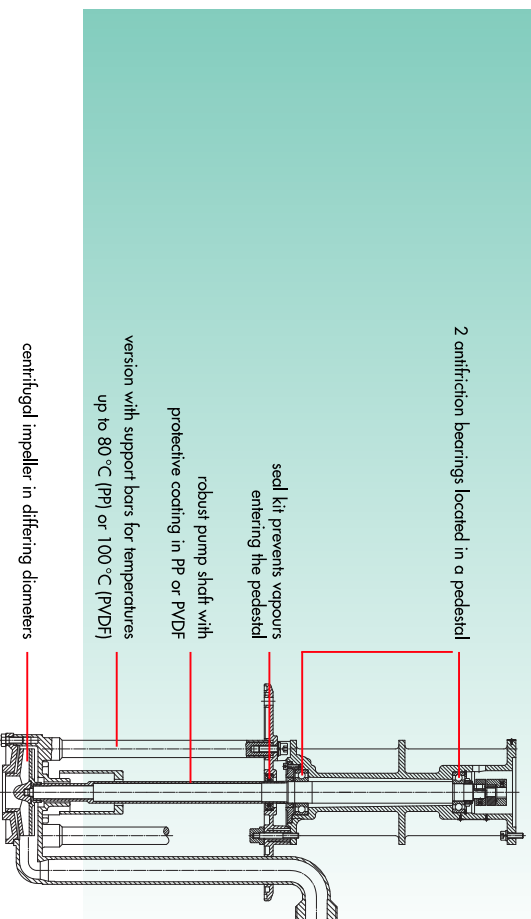

TECHNICAL DATA

Performance chart F 726 PP2-115 and F 726 PVDF2-115

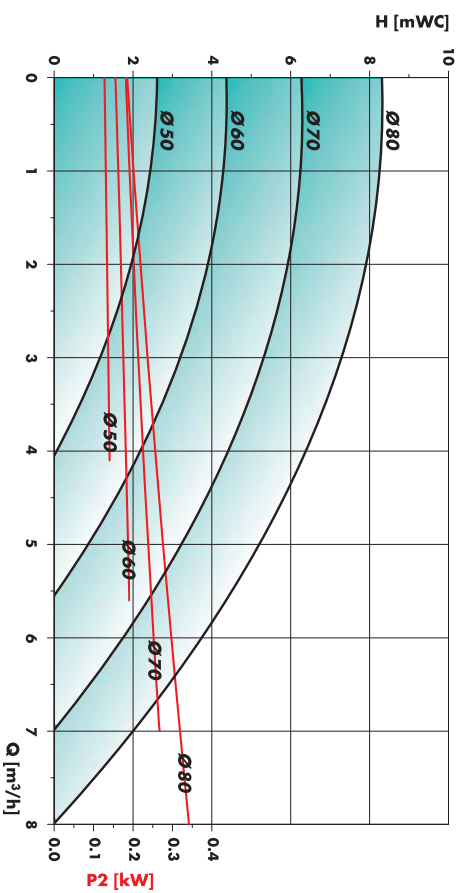

Measured values ± 10% determined with water (20 °C). Nominal speed n = 2850 rpm

In order to achieve the desired output, centrifugal impellers in differing diameters are available.

In determining the absorbed kW of the motor, multiply the absorbed kW shown in the above diagram with the specific gravity of the liquid to be pumped.

Performance chart F 726 PP2-135 and F 726 PVDF2-135

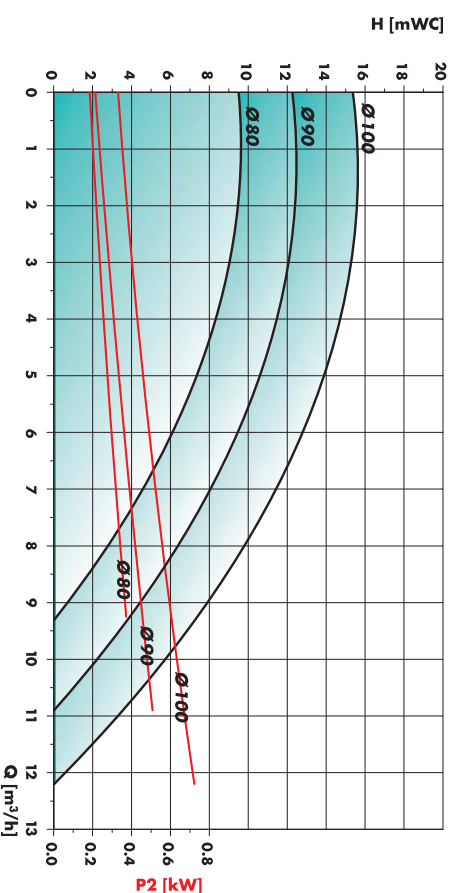

TECHNICAL DATA

Dimensions F 726 PP2-115 and F 726 PVDF2-115

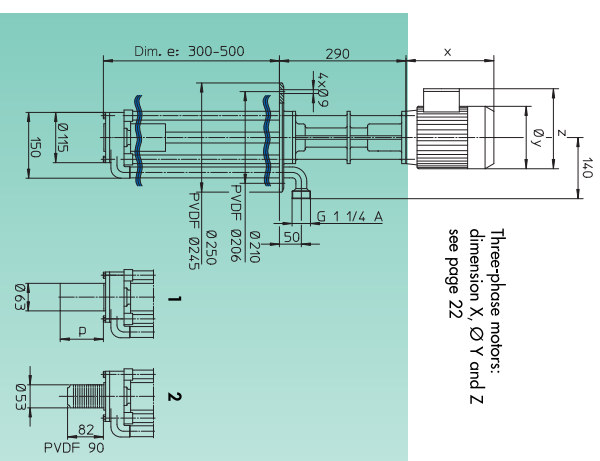

Three-phase motors:
dimension X, Ø Y and Z
see page 22

Basic model
dimension e max. 500 mm

Variant 1
with extension tube
dimension p max. 1000 mm

Variant 2
with suction strainer

Variant 3
with extension tube
and suction strainer

Dimensions F 726 PP2-135 and F 726 PVDF2-135

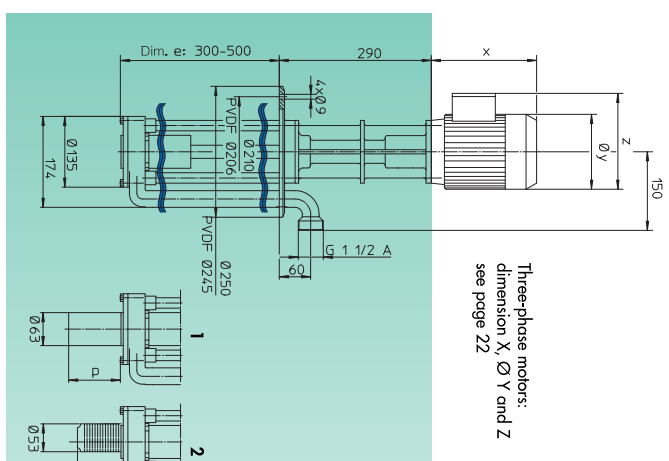

Three-phase motors:
dimension X, Ø Y and Z
see page 22

 Minimum or maximum liquid level
when starting the pump.
Also valid for the variants 1, 2 and 3

Basic model
dimension e max. 500 mm

Variant 1
with extension tube
dimension p max. 1000 mm

Variant 2
with suction strainer

Variant 3
with extension tube
and suction strainer

CENTRIFUGAL IMMERSION PUMP F 726 PP IN POLYPROPYLENE AND F 726 PVDF IN POLYVINYLIDENFLUORIDE, VERSION WITH SUPPORT BARS, WITHOUT DRIVE MOTOR

Type / Size	F 726 PP2-115	F 726 PP2-135	F 726 PVDF2-115	F 726 PVDF2-135
Delivery rate Q max.	8 m ³ /h	12 m ³ /h	8 m ³ /h	12 m ³ /h
Delivery head H max.	8 m water column	15 m water column	8 m water column	15 m water column
Viscosity max.	150 mPas (cP)	150 mPas (cP)	150 mPas (cP)	150 mPas (cP)
Temperature max.	80 °C	80 °C	100 °C	100 °C
Seal material	no bearings nor seals in contact with the liquid			
Material	shaft in stainless steel 1.4571/316 Ti with protective coating in PP			
Centrifugal impeller in PP or PVDF	Ø 50 – 80 mm	Ø 80 – 100 mm	Ø 50 – 80 mm	Ø 80 – 100 mm
Pump housing	Ø 150 mm	Ø 174 mm	Ø 150 mm	Ø 174 mm
Mounting flange in PP or PVDF	outside Ø 250 mm	outside Ø 250 mm	outside Ø 245 mm	outside Ø 245 mm
Thread on outlet	G 1 1/4 A (BSP 1 1/2" male)	G 1 1/2 A (BSP 1 1/2" male)	G 1 1/4 A (BSP 1 1/2" male)	G 1 1/2 A (BSP 1 1/2" male)
Part No.				
Immersion length	300 mm	726 42 003	726 42 103	726 62 003
Dimension e	400 mm	726 42 004	726 42 104	726 62 004
	500 mm	726 42 005	726 42 105	726 62 005

Accessories:

Extension tube in PP or PVDF in steps of 100 mm. Dimension p up to max. 1000 mm.
Suction strainer in PP or PVDF welded onto the cover of the pump housing or onto the extension tube.

DRIVE MOTORS FOR CENTRIFUGAL IMMERSION PUMPS F 726 PP AND F 726 PVDF
Three-phase motors protected to IP 55, with cable terminable box

Capacity P 2	Flange Ø	Voltage	Frequency	Nominal speed	Part No.
0,37 kW	120 mm	230/400 V	50 Hz	2850 rpm	001 00 004
0,55 kW	120 mm	230/400 V	50 Hz	2850 rpm	001 00 005
0,75 kW	120 mm	230/400 V	50 Hz	2850 rpm	001 00 019

Drive motors explosion-proof to Ex e III T3 with cable terminal box on request.

SCOPE OF SUPPLY

A complete vertical centrifugal immersion pump consists of: drive motor, pump with mounting flange and the necessary accessories.
Weight per pump 17 – 30 kg depending on the pump size, immersion length and motor kW.

CENTRIFUGAL IMMERSION PUMP F 726 PP AND F 726 PVDF

FLUX CENTRIFUGAL IMMERSION PUMPS F 726 PP AND F 726 PVDF IN POLYPROPYLENE OR POLYVINYLIDENFLUORIDE SIZE 185 AND 230

Typical applications

Transferring and circulating of neutral or corrosive liquids in the whole field of the chemical industry and chemical engineering, electroplating industry, steel or stainless steel pickling plants, flue gas decontamination, exhaust air purification, water and waste-water treatment.

Construction features

Vertical centrifugal immersion pump for stationary application.
The robust pump shaft is mounted in an upper pedestal and supported by two antifriction bearings. This construction, with the bearings spaced along the pedestal, ensures that any radial or axial forces are absorbed, even under heavy load. The result is a very smooth running pump. The solid version with support bars prevents the rotating elements from making contact with the pump housing and guarantees a very long service life, even in continuous use applications. As neither bearing nor seals are in contact with the liquid, the pump is very wear-resistant and suitable for dry running operation.
The immersion length of the pump can be extended, up to 1500 mm maximum, by the suction tube option. A suction strainer welded onto the cover of the pump housing or onto the extension tube protects the pump against the ingress of coarse impurities.

A range of carefully chosen impeller diameters, together with a range of three-phase motors in differing kW-ratings, ensures the optimum selection of pumps to meet the specific operating requirements.

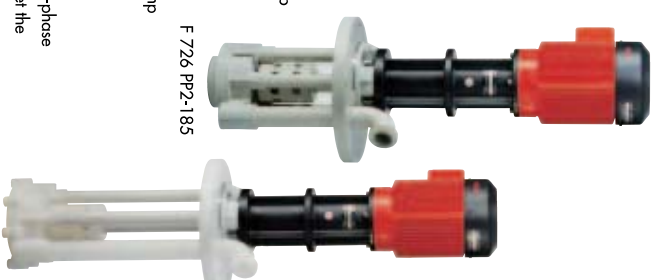

CONSTRUCTION FEATURES IN DETAIL

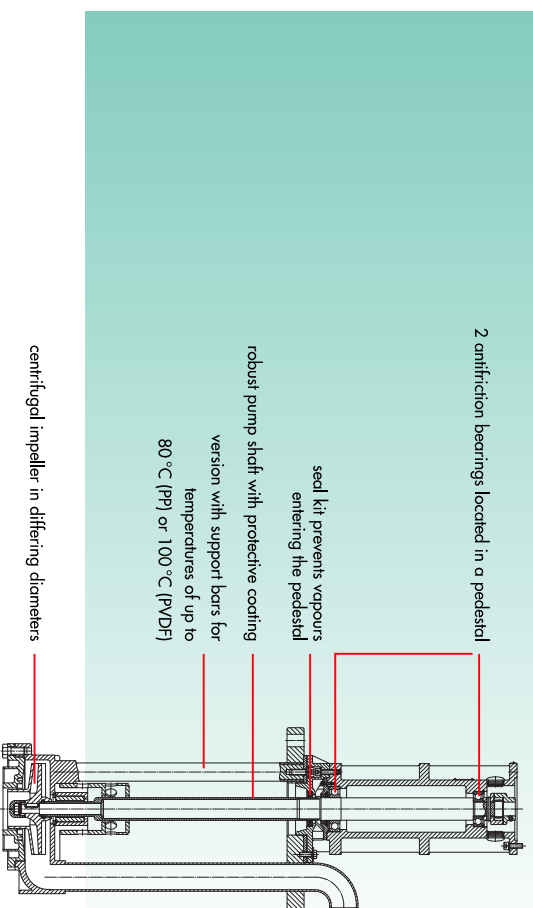

TECHNICAL DATA

Performance chart F 726 PP2-185 and F 726 PVDf2-185

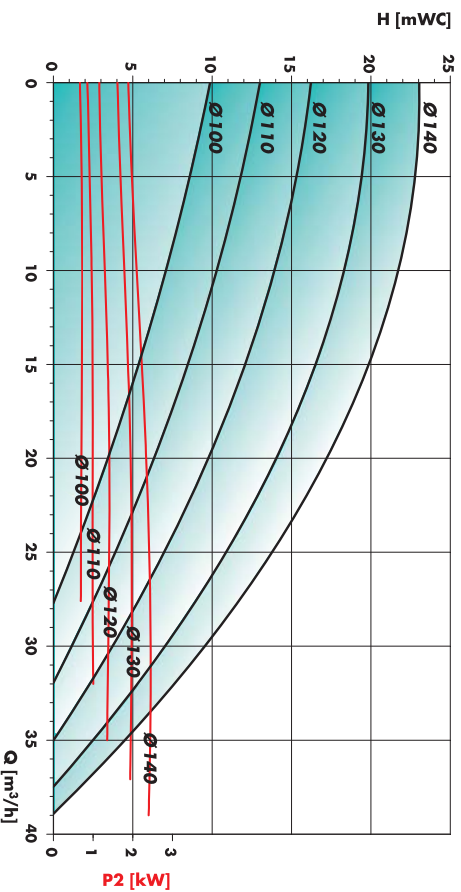

Measured values $\pm 10\%$ determined with water (20 °C). Nominal speed $n = 2850$ rpm

In order to achieve the desired output, centrifugal impellers in differing diameters are available.

In determining the absorbed kW of the motor, multiply the absorbed kW shown in the above diagram with the specific gravity of the liquid to be pumped.

Performance chart F 726 PP2-230 and F 726 PVDf2-230

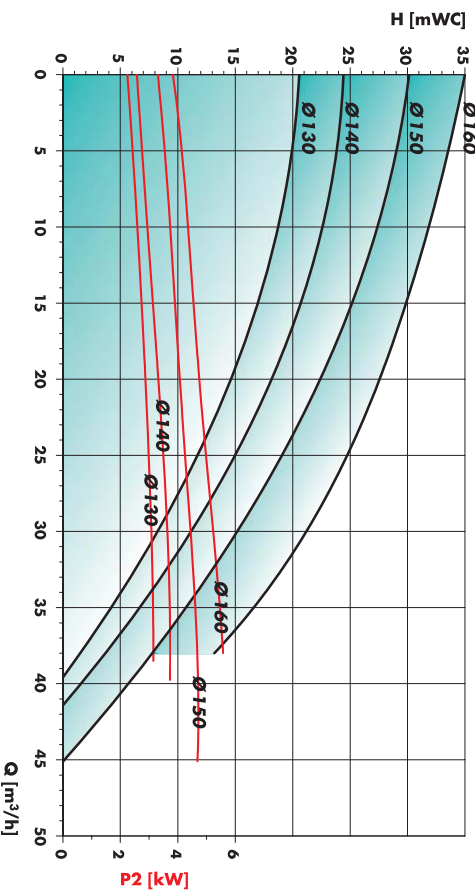

TECHNICAL DATA

Dimensions F 726 PP2-185 and F 726 PVDf2-185

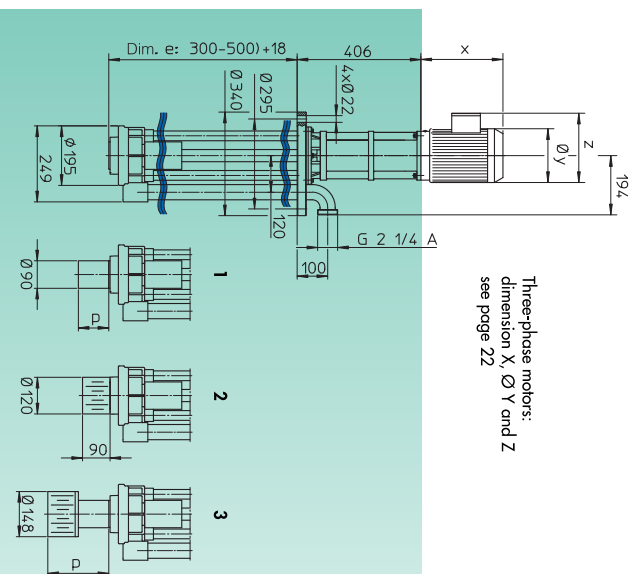

Three-phase motors:
dimension X, Ø Y and Z
see page 22

Basic model
dimension e max. 500 mm

Variant 1
with extension tube
dimension p max. 1500 mm

Variant 2
with suction strainer

Variant 3
with extension tube
and suction strainer

Dimensions F 726 PP2-230 and F 726 PVDf2-230

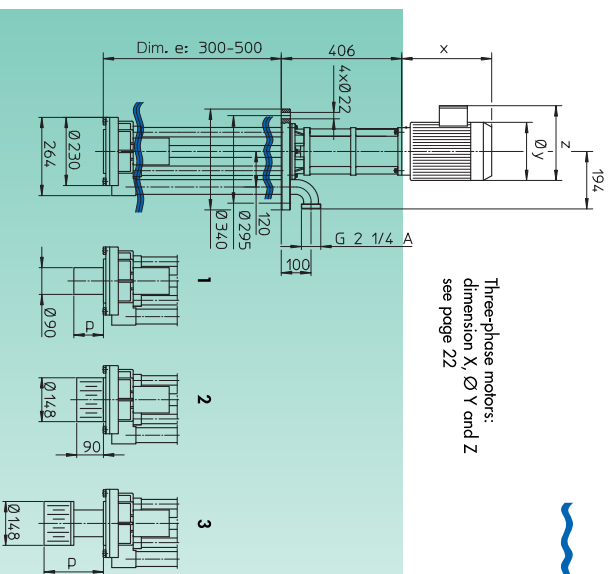

Three-phase motors:
dimension X, Ø Y and Z
see page 22

Minimum or maximum liquid level
when storing the pump.
Also valid for the variants 1, 2 and 3

Basic model
dimension e max. 500 mm

Variant 1
with extension tube
dimension p max. 1500 mm

Variant 2
with suction strainer

Variant 3
with extension tube
and suction strainer

CENTRIFUGAL IMMERSION PUMP F 726 PP IN POLYPROPYLENE AND F 726 PVDF IN POLYVINYLIDENFLUORIDE, VERSION WITH SUPPORT BARS, WITHOUT DRIVE MOTOR

Type / Size	F 726 PP2-185	F 726 PP2-230	F 726 PVDF2-185	F 726 PVDF2-230
Delivery rate Q max.	38 m ³ /h	45 m ³ /h	38 m ³ /h	45 m ³ /h
Delivery head H max.	23 m water column	35 m water column	23 m water column	35 m water column
Viscosity max.	150 mPas (cP)	150 mPas (cP)	150 mPas (cP)	150 mPas (cP)
Temperature max.	80 °C	80 °C	100 °C	100 °C
Seal material		no bearings nor seals in contact with the liquid		
Material		shaft in stainless steel 1.4571/316 Ti with protective coating in PP		
Centrifugal impeller in PP or PVDF	Ø 100 – 140 mm	Ø 130 – 160 mm	Ø 100 – 140 mm	Ø 130 – 160 mm
Pump housing	Ø 249 mm	Ø 264 mm	Ø 249 mm	Ø 264 mm
Mounting flange in PP or RCH 1000	outside Ø 340 mm	outside Ø 340 mm	outside Ø 340 mm	outside Ø 340 mm
Thread on outlet	G 2 1/4 A (BSP 2 1/4" male)	G 2 1/4 A (BSP 2 1/4" male)	G 2 1/4 A (BSP 2 1/4" male)	G 2 1/4 A (BSP 2 1/4" male)
Part No.	726 42 203	726 42 303	726 62 203	726 62 303
Immersion length	400 mm	726 42 204	726 62 204	726 62 304
Dimension e	500 mm	726 42 205	726 62 205	726 62 305

Accessories:

Extension tube in PP or PVDF in steps of 100 mm, Dimension P up to max. 1500 mm.
Suction strainer in PP or PVDF welded onto the cover of the pump housing or onto the extension tube.

DRIVE MOTOR FOR CENTRIFUGAL IMMERSION PUMP F 726 PP

Three-phase motors protected to IP 55, with cable terminal box

Capacity P 2	Flange Ø	Voltage	Frequency	Nominal speed	Part No.
1,5 kW	160 mm	230/400 V	50 Hz	2850 rpm	001 00 008
2,2 kW	160 mm	230/400 V	50 Hz	2850 rpm	001 00 009
3,0 kW	160 mm	400 V	50 Hz	2850 rpm	001 00 010
4,0 kW	160 mm	400 V	50 Hz	2850 rpm	001 00 011
5,5 kW	160 mm	400 V	50 Hz	2850 rpm	001 00 015

Three-phase motors explosion-proof to EEx e II T3 with cable terminal box on request.

SCOPE OF SUPPLY

A complete vertical centrifugal immersion pump consists of drive motor, pump with mounting flange and the necessary accessories.
Weight per pump 25 – 75 kg depending on the pump size, immersion length and motor kW.

CENTRIFUGAL IMMERSION PUMP F 726 PP AND F 726 PVDF

DIMENSIONS OF THREE-PHASE MOTORS PROTECTED TO IP 55

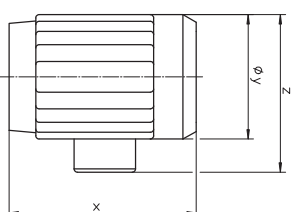

Capacity P 2	Nominal speed	X	Ø Y	Z
0,37 kW	2850 rpm	201	143	183
0,55 kW	2850 rpm	201	143	183
0,75 kW	2850 rpm	232	158	201
1,1 kW	2850 rpm	232	158	201
1,5 kW	2850 rpm	244	176	227
2,2 kW	2850 rpm	269	176	227
3,0 kW	2850 rpm	303	196	252
4,0 kW	2850 rpm	320	220	277
5,5 kW	2850 rpm	405	246	313
3,0 kW	1450 rpm	303	196	252
4,0 kW	1450 rpm	320	220	277
5,5 kW	1450 rpm	405	246	313

DIMENSIONS OF THREE-PHASE MOTORS EXPLOSION-PROOF TO EEX e II T3

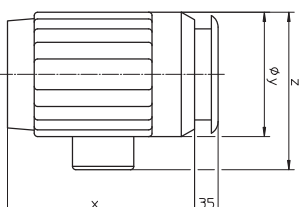

Capacity P 2	Nominal speed	X	Ø Y	Z
0,75 kW	2850 rpm	232	158	212
1,1 kW	2850 rpm	232	158	212
1,5 kW	2850 rpm	244	176	237
2,0 kW	2850 rpm	269	176	237
2,5 kW	2850 rpm	303	196	256
3,3 kW	2850 rpm	320	220	279

QUESTIONNAIRE TO QUOTE ON
FLUX VERTICAL CENTRIFUGAL IMMERSION PUMPS

REQUESTED VERSION

- for portable application for stationary application for horizontal application

LIQUID DATA

Description _____ Chemical Formula _____
 Concentration _____ % Specific gravity _____ g/cm³
 Viscosity _____ mPas/cP at _____ °C Operating temperature _____ °C
 Solids in suspension _____ g/l hard soft Size of solids _____ mm
 Does liquid crystallize? Yes No at _____ °C

Which materials are resistant to liquid according to previous experience?

OPERATING DATA

Delivery rate _____ m³/h Delivery head _____ m water column
 Immersion length _____ mm Suction strainer Yes No
 Mounting flange in special dimensions: Extension tube Yes No
 outside Ø _____ mm, p. c. Ø _____ mm Dimension p = _____ mm
 pressure flange Oui Non
 outside Ø _____ mm, p. c. Ø _____ mm Ø of the container opening _____ mm
 Operating time per day _____ Number of starts _____

DRIVE MOTOR

Three-phase motor Operating voltage _____ Volt _____ Hz
 Is motor to be explosion-proof? Yes No

QUOTATION TO BE SENT BY:

Telephone e-mail Telefax
 Mr. / Mrs: _____ Title: _____
 Company: _____
 Address: _____
 ZIP / City / Country: _____
 Phone: _____ Fax: _____
 Mobile: _____ eMail: _____

THE GREAT RANGE OF FLUX PUMPS

YES!

I am interested in top class pump technology.
Please send the following catalogues:

- FLUX LABORATORY PUMPS
- FLUX BARREL PUMPS
- FLUX CONTAINER PUMP
- FLUX HIGH VISCOSITY LIQUID PUMPS
- FLUX AIR-OPERATED DIAPHRAGM PUMPS
- FLUX LIQUID METERS
- FLUX PROCESS CONTROL SYSTEM PCS



THE GREAT RANGE OF FLUX PUMPS

Mr. / Mrs:

Company:

Address:

ZIP / City / Country:

Telephone:

Fax:

eMail:

Please mark with a cross, complete the address and then sent us a fax. Fax number see on the back side!