

Boxer 100



Specifications and types



Zone 2 - Zone 22	II 3G Ex h IIB T4 Gc e II 3D Ex h IIIB T135°C Dc X
Zone 1 - Zone 21	II 2G Ex h IIB T4 Gb e II 2D Ex h IIIB T135°C Db X
Zone 1 - Zone 21	II 2G Ex h IIC T4 Gb
Zone M2	I M2 Ex h I Mb X *
IECEX	Ex h IIB T4 Gb e Ex h IIIB T135°C Db

** The Group IIC gas application string is applicable on Boxer series pumps in Conduct version with Conductive TFM diaphragms.
* The mining application string does not apply to aluminium pumps in the Boxer range.

Suction / delivery connections Boxer 100	1" f BSPP (*)
Suction / delivery connections FDA Boxer 100	1 1/2" Clamp BS 4825'
Air fitting	3/8" f BSPP
Max. flow rate*	160 l/min
Max. supply air pressure	8 bar
Max. head*	80 m
Max negative suction head - dry-running**	4 m
Max negative suction head - with pump primed	9,5 m
Max. diameter suspended solids	4 mm
Noise	75 dB

(*) NPT fittings only on request

* The curves and the performances refer to pumps with immersed suction and open delivery outlet, with water at 20°C and vary depending on material composition.

** The value depends on the pump configuration.



PLASTIC MATERIAL PP (GF/CF) - PVDF

Boxer 100



Maximum dimensions

Height	325 mm
Width	329 mm
Depth	202 mm



Construction mat. (casing and manifolds) and net weight

POLYPROPYLENE (with glass additive)	7,5 Kg Temp. 3°C min. 65°C max
CONDUCTIVE POLYPROPYLENE (with carbon additive)	7,5 Kg Temp. 3°C min. 65°C max
PVDF (with carbon additive)	8,5 Kg Temp. 3°C min. 95°C max

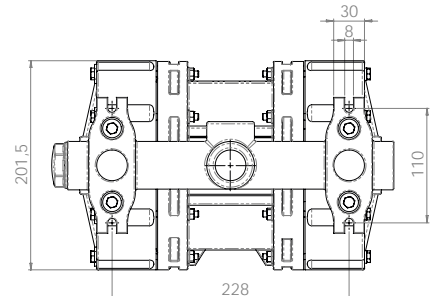
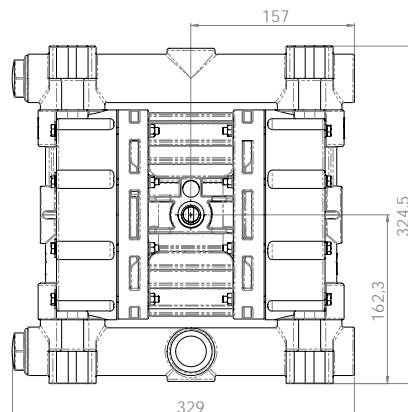
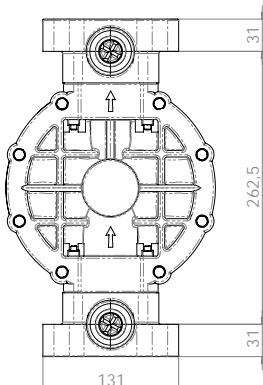

Boxer 100



Specifications and types



Zone 2 - Zone 22
Zone 1 - Zone 21
Zone 1 - Zone 21
Zone M2
IECEX

II 3G Ex h IIB T4 Gc e II 3D Ex h IIIB T135°C Dc X
II 2G Ex h IIB T4 Gb e II 2D Ex h IIIB T135°C Db X
II 2G Ex h IIC T4 Gb
I M2 Ex h I Mb X *
Ex h IIB T4 Gb e Ex h IIIB T135°C Db

** The Group IIC gas application string is applicable on Boxer series pumps in Conduct version with Conductive TFM diaphragms.
* The mining application string does not apply to aluminium pumps in the Boxer range.



METAL MATERIAL - ALU

Boxer 100



Maximum dimensions

Height	324 mm
Width	315 mm
Depth	202 mm



Construction mat. (casing and manifolds) and net weight

ALU	8,2 Kg Temp. 3°C min. 95°C max
-----	--------------------------------------

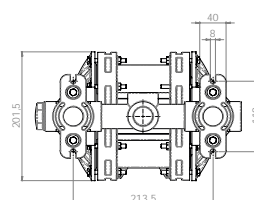
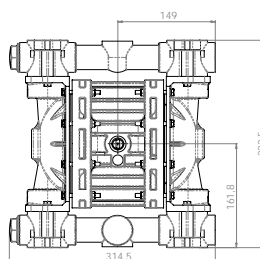
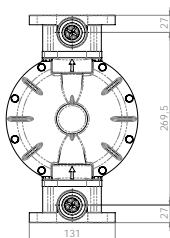

METAL MATERIAL - AISI 316

Boxer 100



Maximum dimensions

Height	327 mm
Width	308 mm
Depth	202 mm



Construction mat. (casing and manifolds) and net weight

AISI 316	11 Kg Temp. 3°C min. 95°C max
----------	-------------------------------------

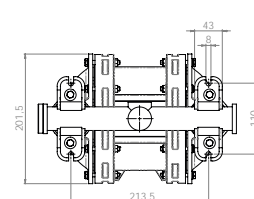
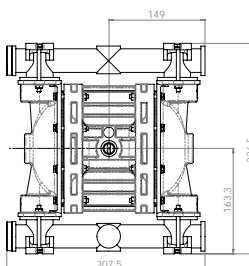
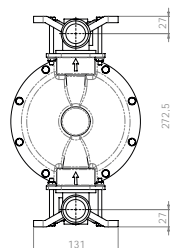

FDA BOXER 100



METAL MATERIAL - AISI 316 L

FDA Boxer 100



Maximum dimensions

Height	358 mm
Width	342 mm
Depth	202 mm



Construction mat. (casing and manifolds) and net weight

AISI 316	11,7 Kg Temp. 3°C min. 95°C max
----------	---------------------------------------

Boxer 100



Specifications and types



Zone 2 - Zone 22
Zone 1 - Zone 21
Zone 1 - Zone 21
Zone M2
IECEX

II 3G Ex h IIB T4 Gc e II 3D Ex h IIIB T135°C Dc X
II 2G Ex h IIB T4 Gb e II 2D Ex h IIIB T135°C Db X
II 2G Ex h IIC T4 Gb
I M2 Ex h I Mb X *
Ex h IIB T4 Gb e Ex h IIIB T135°C Db

** The Group IIC gas application string is applicable on Boxer series pumps in Conduct version with Conductive TFM diaphragms.
* The mining application string does not apply to aluminium pumps in the Boxer range.

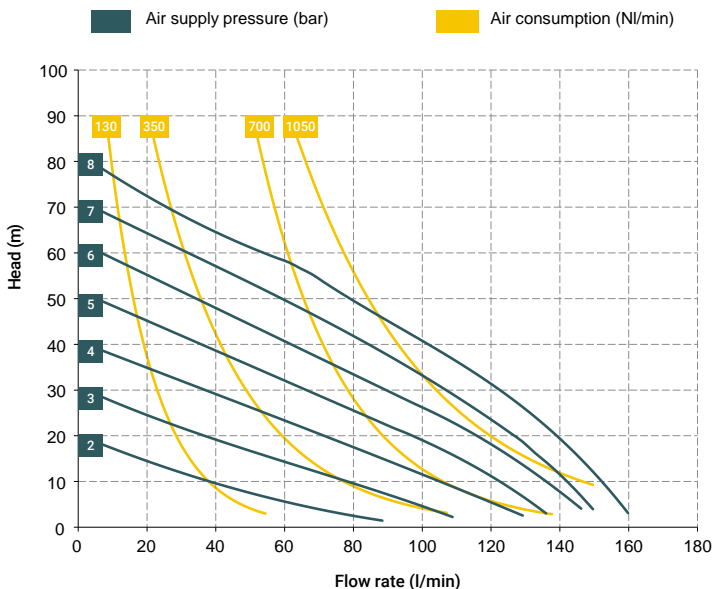

* The curves and performances refer to pumps with immersed suction and open delivery outlet with water at 20 °C and vary according to the composition materials.

BOXER 100 (PP):

A1 - A2 - A3 - A4 - A5 - A6 - M1 - M2 - M3 - M4 - M5 - M6

BOXER 100 (PVDF):

A1 - A2 - A3 - A4 - A5 - A6 - M1 - M2 - M3 - M4 - M5 - M6

BOXER 100 (ALU):

A1 - A2 - A3 - A4 - A5 - A6 - M1 - M2 - M3 - M4 - M5 - M6

Standard fittings:

- Suction: A1
- Delivery: M1

BOXER 100 (INOX):

A1 - A2 - A3 - M1 - M2 - M3

Standard fittings:

- Suction: A1
- Delivery: M1



T20 distributor material (compressed air circuit)

- POM

Core material

- Polypropylene (with glass filler)
- Conductive polypropylene (with carbon filler)
- Aisi 316
- Aluminium

Diaphragm materials

- PTFE
- HYTREL®
- SANTOPRENE
- NBR
- EPDM

Cap materials

- Polypropylene (with glass filler)
- Conductive polypropylene (with carbon filler)
- PVDF
- Aluminium
- Natural ECTFE
- AISI 316 L

Ball materials

- PTFE
- AISI 316 L
- EPDM
- NBR

O-ring materials

- EPDM
- NBR
- VITON®
- PTFE

Packaging

Cardboard box - 27 x 39 x 41 cm - weight 1,4 kg
(the weight refers only to the packaging without the pump inside)

Accessories

- Equaflux 200 (For damper materials, please refer to the technical data sheet)
- Truck model 01
- Foot valve
- Air regulation kit W3000-10-G
- Batch controller
- Stroke counter
- Reinforcement rings
- Flange kit (DIN flanges - ANSI on request)

Any colour variations in our polypropylene and PVDF products are due to the special blends of the raw materials used. The use of high levels of glass and long-fiber carbon filler result in a unique colour that does not in any way affect the quality of the product; on the contrary, it points to the high level of content used to ensure outstanding performance.

Boxer 100



Specifications and types



Zone 2 – Zone 22
Zone 1 – Zone 21
Zone 1 – Zone 21
Zone M2
IECEX

II 3G Ex h IIB T4 Gc e II 3D Ex h IIIB T135°C Dc X
II 2G Ex h IIB T4 Gb e II 2D Ex h IIIB T135°C Db X
II 2G Ex h IIC T4 Gb
I M2 Ex h I Mb X *
Ex h IIB T4 Gb e Ex h IIIB T135°C Db

** The Group IIC gas application string is applicable on Boxer series pumps in Conduct version with Conductive TFM diaphragms.
* The mining application string does not apply to aluminium pumps in the Boxer range.

BOXER PUMPS CODES ENCODING

ex. IB100-P-HTTPV--
Internal distributor, Boxer 100, body PP, air-side diaph. Hytrel®, product-side diaph. PTFE, AISI 316 L balls, PP ball seats, EPDM O-Ring.

IB07-	P	H	T	T	P	V	-	-
PUMP MODEL	PUMP BODY	AIR-SIDE DIAPHRAGM	FLUID-SIDE DIAPHRAGM	BALLS	BALL SEATS	O-RING	MANIFOLD	VERSION
IB07 - Boxer 07 IB15 - Boxer 15 IMICR - Microboxer IB35 - Boxer 35 IB50 - Boxer 50 IMIN - Miniboxer IB81 - Boxer 81 IB90 - Boxer 90 IB100 - Boxer 100 IB150 - Boxer 150 IB251 - Boxer 251 IB252 - Boxer 252 IB522 - Boxer 522 IB502 - Boxer 502 IB503 - Boxer 503	P - PP PC - PP+CF FC - PVDF+CF A - AISI 316 (L) AL - ALU	N - NBR D - EPDM H - Hytrel® M - Santoprene®	T - PTFE	T - PTFE A - AISI 316 L D - EPDM N - NBR	P - Polypropylene F - PVDF A - AISI 316 L I - PE-UHMW R - PPS L - Aluminium	D - EPDM V - Viton® N - NBR T - PTFE	X* 3* Y* W* K*	C* Z*

Example table, for the table with the complete codes please contact the Debem sales department.



*X = split manifold
*3 = 3rd hole on the manifold
*Y = manifold with NPT fitting
*W = clamp manifold
*K = manifold with reinforcement rings (all on request only)
C = CONDUCT version for ATEX ZONE 1
Z = Version for IECEx Standard



Self priming



Under head

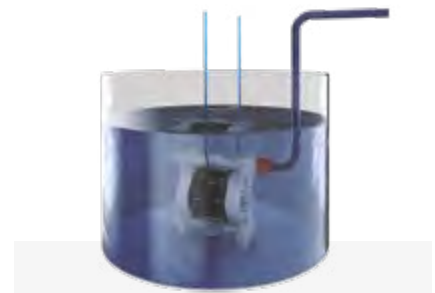

Immersed



Drum Transfer

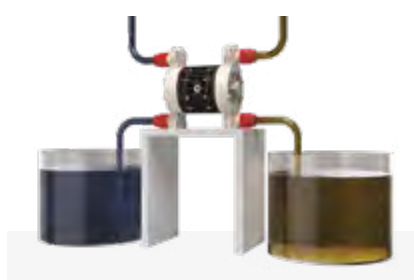

Split Suction

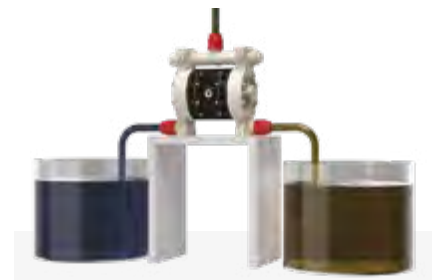

Split Suction and Delivery