

HORIZONTAL CENTRIFUGAL PUMPS

MB 180

MADE IN ITALY 

- **Product of Italian origin**
- Available in PP-PVDF
- Below head use
- No welded seams
- Seal: available with mechanical bellows seal (316 STAINLESS STEEL spring - SILICON CARBIDE + CERAMIC / SILICON CARBIDE + SILICON CARBIDE sealing ring) or with lip seal (VITON or EPDM)
- Operation also possible with heavily soiled fluids, with solids in suspension
- Max. flow rate 75 m³/h
- Max head 38 m
- Open impeller Ø 176 mm x H 13 mm (Standard impeller, for any special design with reference to the pumped fluid contact DEBEM's technical support)
- Extremely easy maintenance
- Low cost of spare parts
- Viscosity up to 500 CPS
- OPERATING TEMPERATURES:
PP min. +3°C / max. +65°C
PVDF min. +3°C / max. +95°C
- Continuous operation: YES
- Warranty: 1 year, according to our general conditions of sale.
- Spare parts: to identify the spare parts check the exploded views provided at the end of the operation and maintenance manual.

MODEL	Kw MOTOR	HP	MOTOR SIZE	RPM	MOTOR SPECIFICATIONS
MB180	11	15	B3+B5	2900	THREE-PHASE 400 / 690 V - 50 / 60 HZ 2 POLE efficiency class IE2 protection rating IP55 - Ambient temperature -30°C + 45° C / ATEX motor available

ATTENTION: technical data for standard motor, for any special design with reference to the pumped fluid contact DEBEM's technical support.

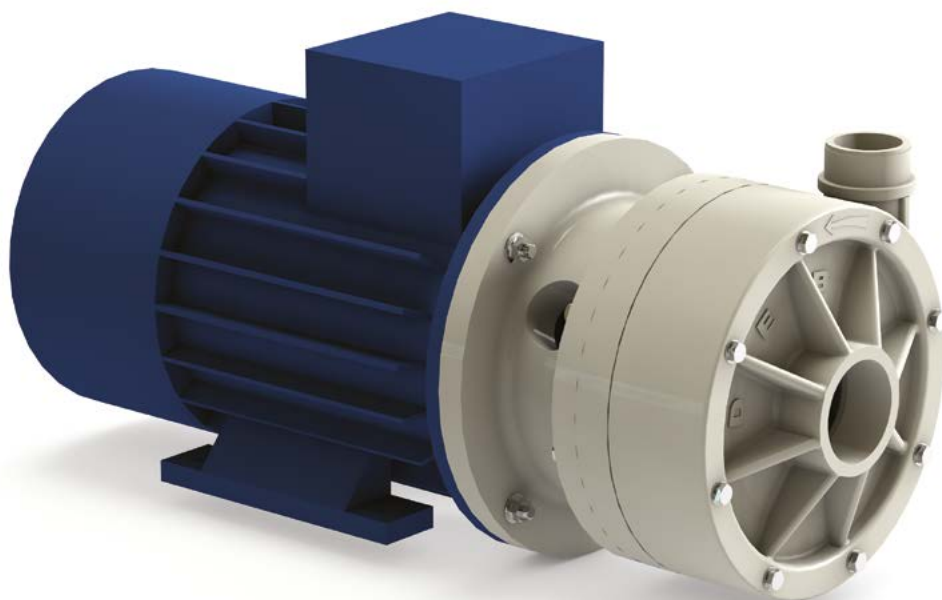

CE

Intake connections G 2" 1/2 f (or DN 65 on request)

Delivery connections G 2" m (or DN 50 on request)

Max. flow rate 75 m³/h

Max. head 38 m

Construction materials PP - PVDF



HORIZONTAL CENTRIFUGAL PUMPS

MB 180

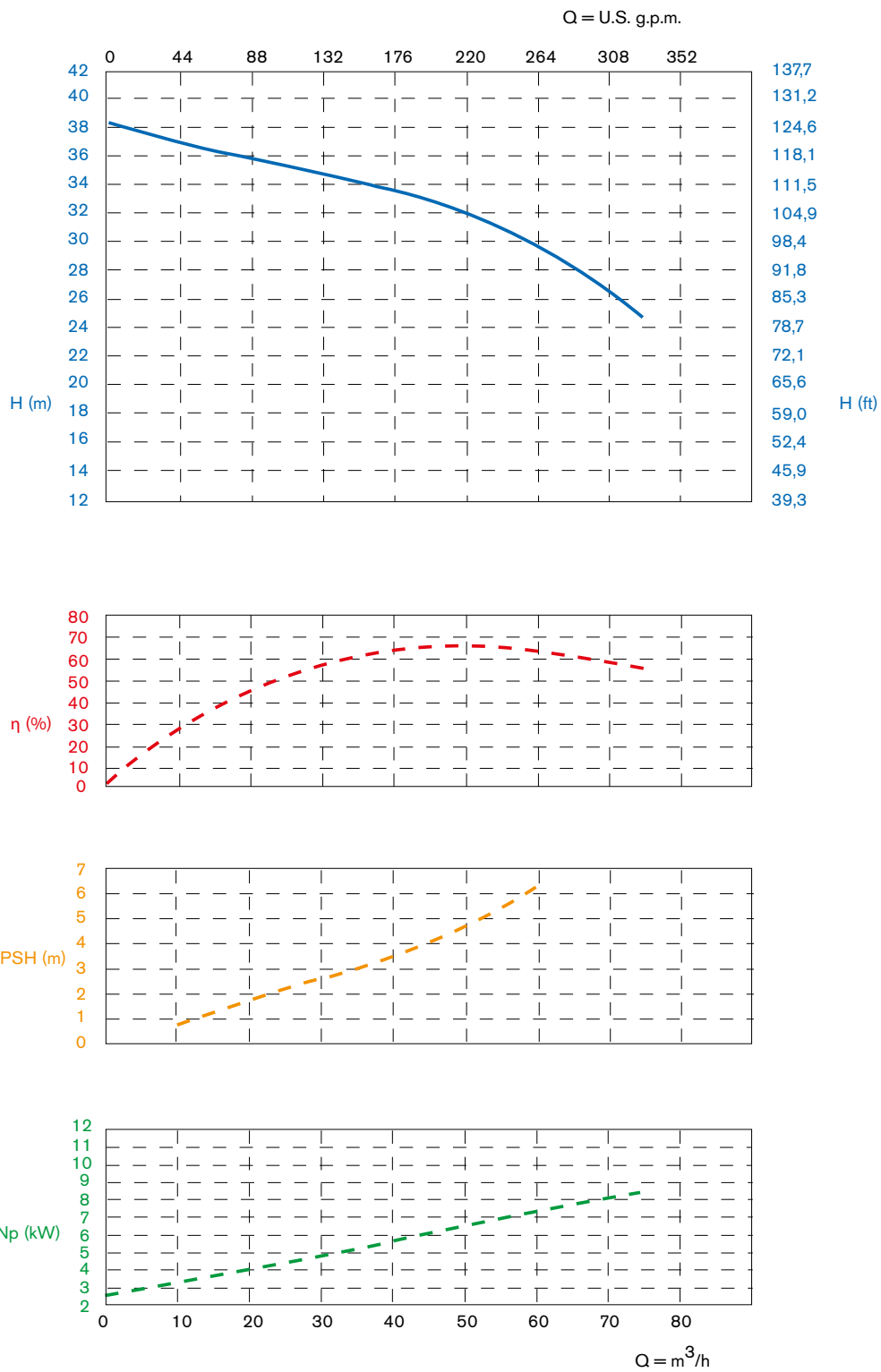

The curves and performance values refer to pumps spare delivery outlet and water at 20°C, 2 pole motor 50 Hz (2900rpm).

AVAILABLE MATERIAL

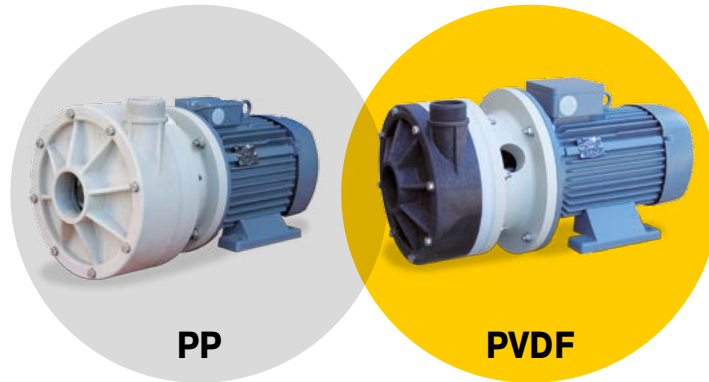

INSTALLATION

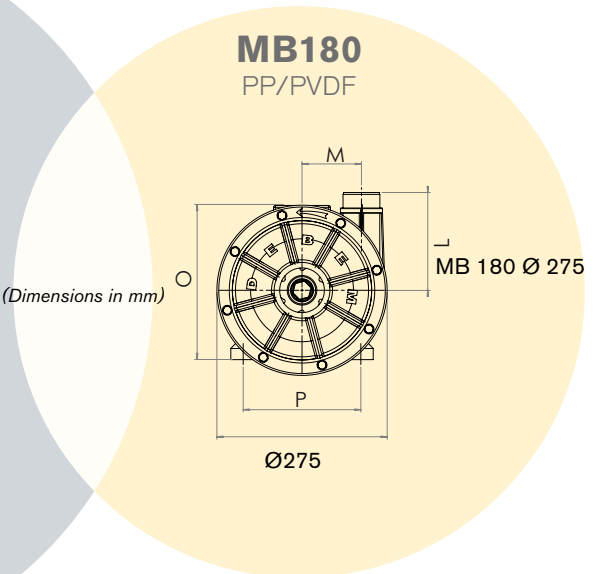
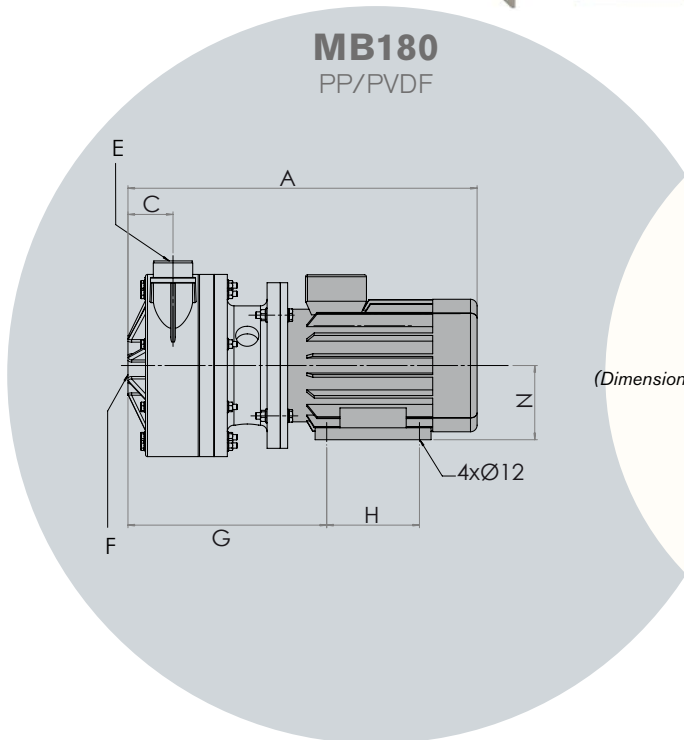
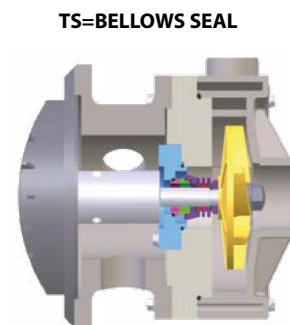
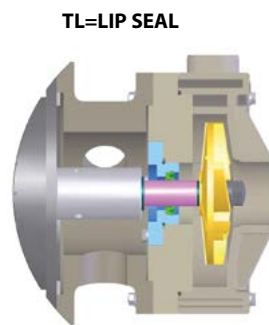
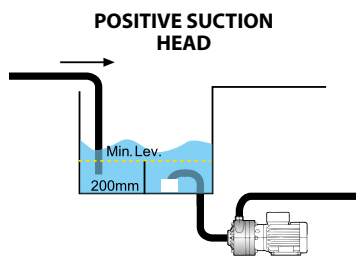

Packing: wooden case - 81 x 40 x 53 cm-weight 19 Kg
(the weight only refers to the packaging without the pump in it).

MODEL	SEAL	POWER	Ø PASSING SOLIDS	A	C	E	F	G	H	L	M	N	O	P	KG PP	KG PVDF
MB180	TL-TS	11 Kw 15 HP	9	695	68	G 2" m o DN 50	G 2" 1/2 f o DN 65	335	178	158	96	132	310	216	96	99

MB COMPOSITION CODE

ex. **MB180P-TLVN**

MB 180 in PP, Viton lip seal, three-phase motor

MB180	P -	TLV	N
PUMP MODEL	PUMP MATERIAL	TYPE OF SEAL	MOTOR
MB180 - MB 180	P - Polypropylene FC - PVDF+CF	TLV - Viton lip seal TLD - EPDM lip seal TSV - Viton bellow seal TSD - EPDM bellow seal	N* - Three-phase motor M - Single-phase motor A - ATEX motor

* Standard motor is the three-phase induction type with European voltage (2-pole) 50Hz

PRODUCT APPLICATION

