



Industrial Peristaltic Pumps

RBT-25/B Data sheet



Capacity: 0,3 l/rev.
Connections: DN-25
Max. Pressure: 15 bar
Rotor system: Shoes
Available hoses: NR
 NBR
 EPDM
 HYPALON
 NR-A
 NBR-A



Pressure (bar)	Torque (Nm)
Minimum	115
5	115
7,5	115
10	140
15	170

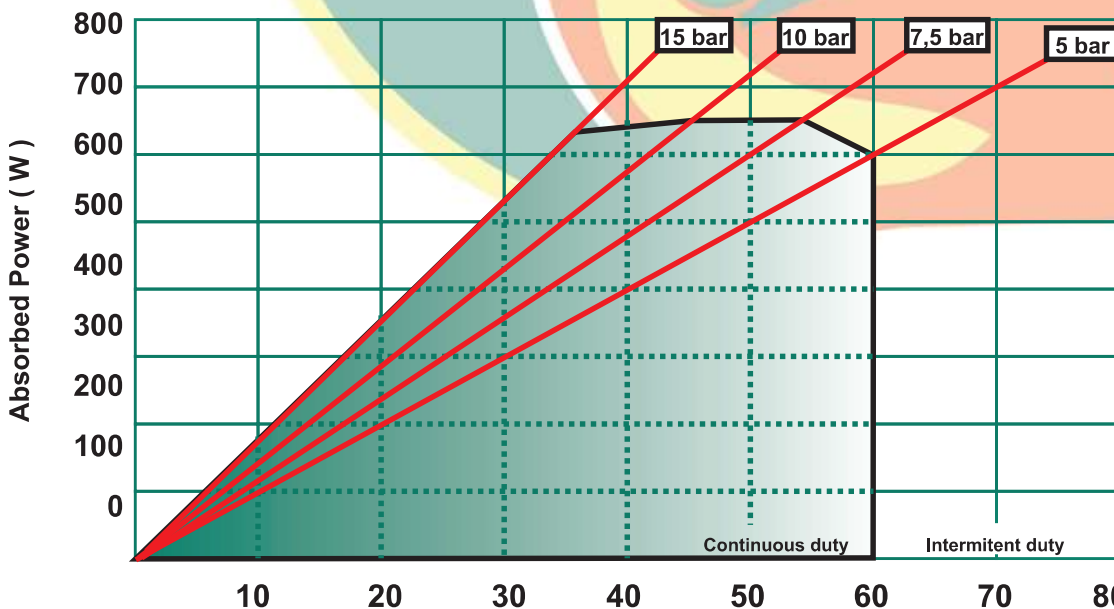

Description	Material	Surface treatment
Pump housing	Cast Iron EN-GJL-250	Polyester powder coated Halar coated (Optional)
Front cover	Steel F-111 / Methacrilate	Polyester powder coated Halar coated (Optional)
Rotor	Nodular Cast Iron EN-GJL-400	Cataphoresis
Shoes	Nodular Cast Iron EN-GJL-400	Hardened
Base plate	Steel F-111 Stainless Steel AISI-304 (Optional)	Polyester powder coated --
Connections	Stainless Steel AISI-316 Polypropylene (Optional) PVDF (Optional)	--

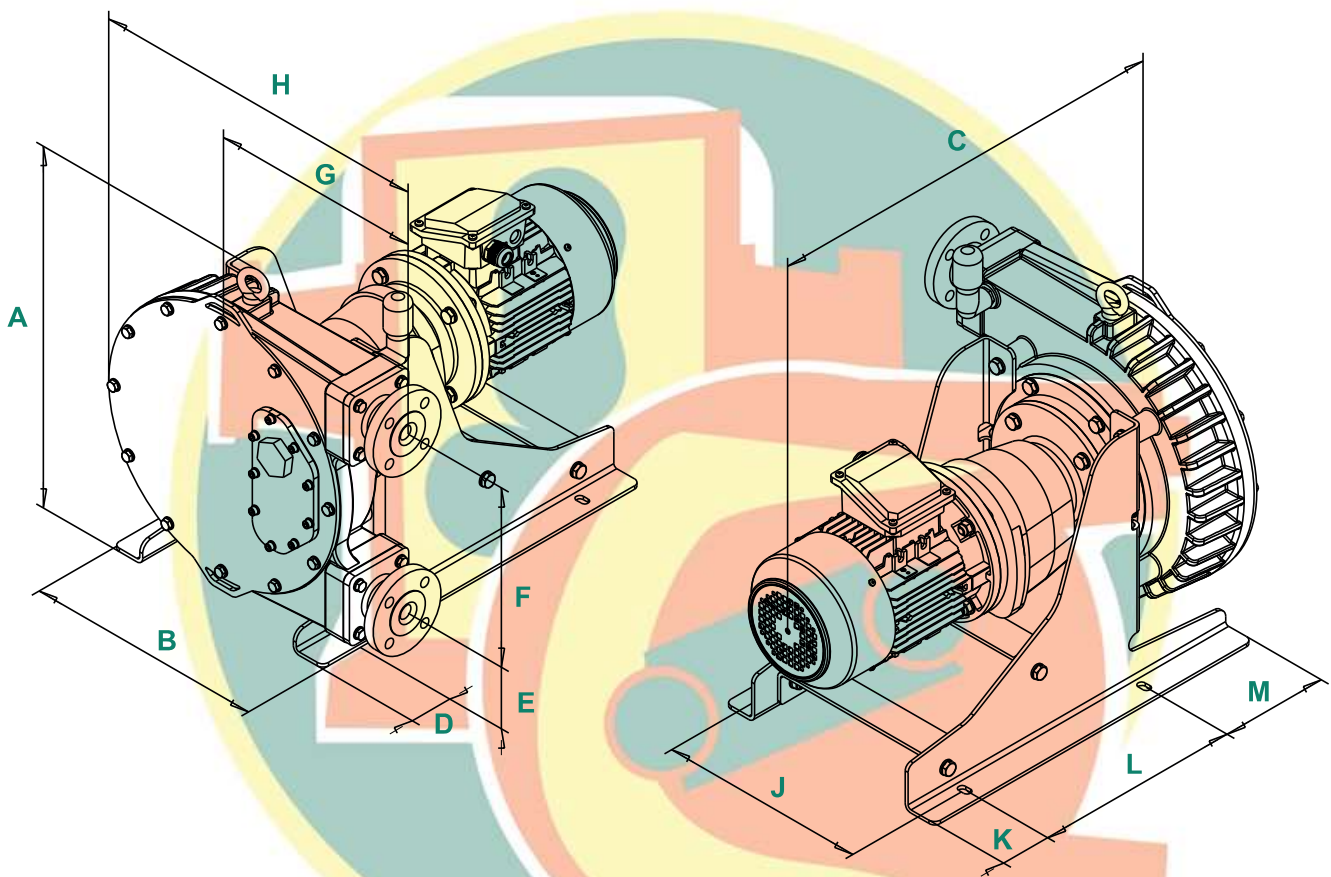

A	B	C	D	E	F	G	H	J	K	L	M	Connections
470	356	*	52	103	264	271	466	308	75	305	160	DIN DN25

* To confirm according type and power driver.



Bombas Boyser, S.L

c/ Miquel Martí i Pol, s/n - Pol. Ind. Pla de la Costa
08182 Sant Feliu de Codines - Barcelona - Spain

Tel. +34 93 844 77 78 info@boyser.com

www.boyser.com

