

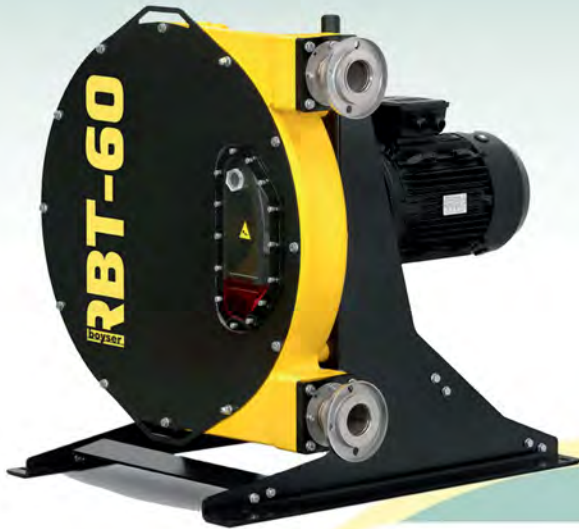

Industrial Peristaltic Pumps

RBT-60/B Data sheet



Capacity:	3,16 l/rev.
Connections:	DN-50
Max. Pressure:	15 bar
Rotor system:	Shoes
Available hoses:	NR NBR EPDM HYPALON



Pressure (bar)	Torque (Nm)
Minimum	800
5	800
7,5	1000
10	1300
15	1700

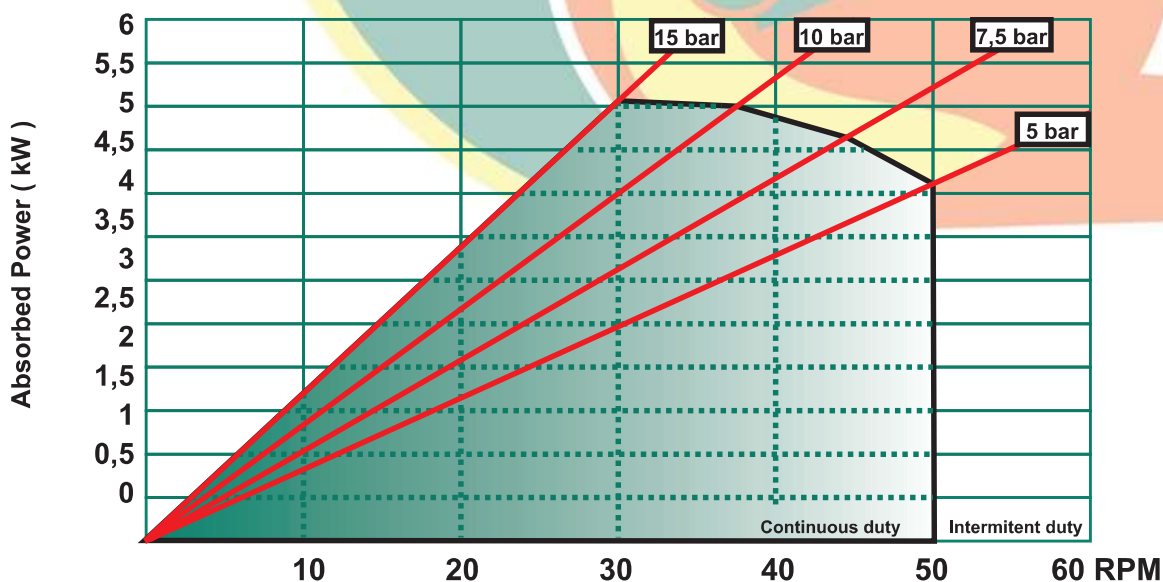

Description	Material	Surface treatment
Pump housing	Cast Iron EN-GJL-250	Polyester powder coated Halar coated (Optional)
Front cover	Steel F-111 / Methacrilate	Polyester powder coated Halar coated (Optional)
Rotor	Nodular Cast Iron EN-GJL-400	Cataphoresis
Shoes	Nodular Cast Iron EN-GJL-400	Hardened
Base plate	Steel F-111 Stainless Steel AISI-304 (Optional)	Polyester powder coated --
Connections	Stainless Steel AISI-316 Polypropylene (Optional) PVDF (Optional)	--

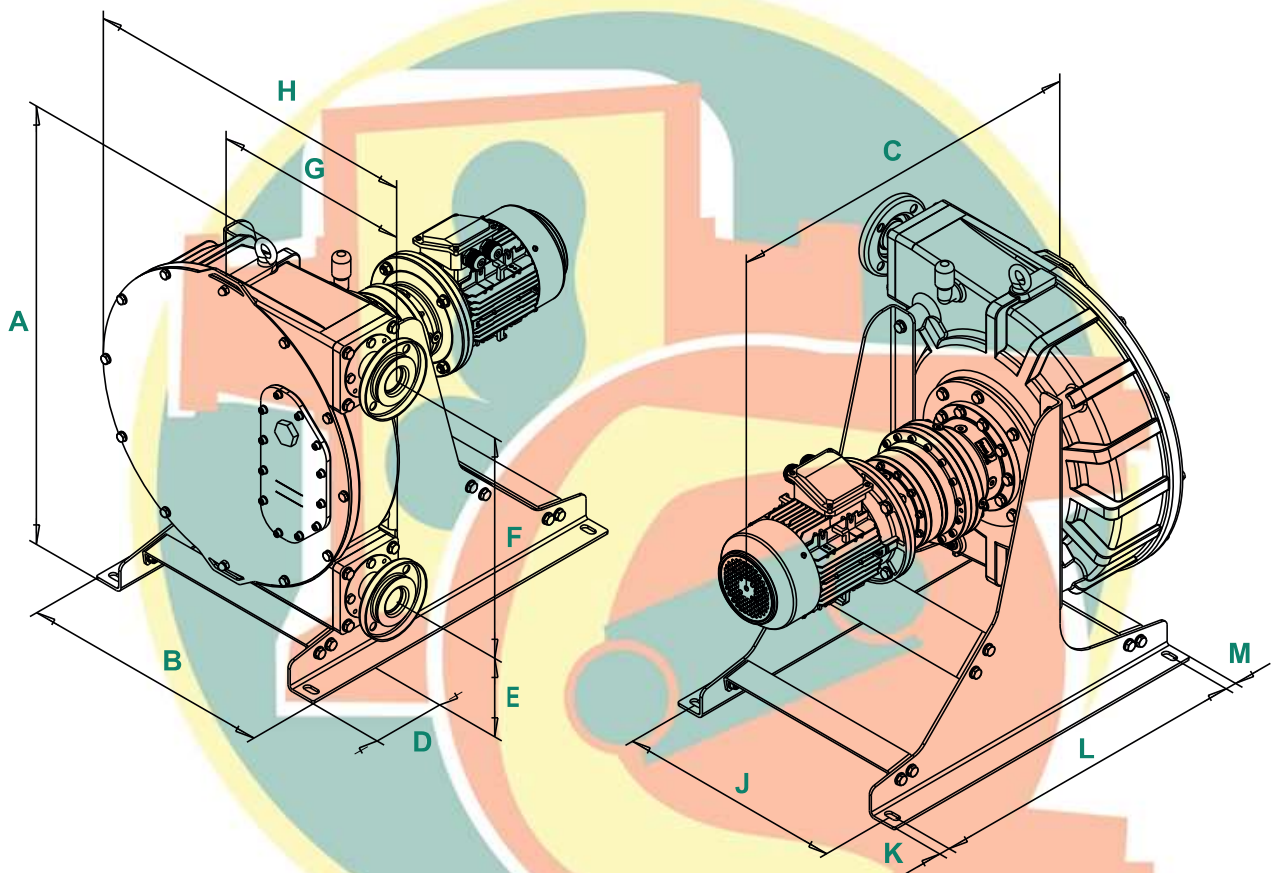

A	B	C	D	E	F	G	H	J	K	L	M	Connections
850	580	*	136	212	510	379	708	520	25	740	25	DIN DN50

* To confirm according type and power driver.



Bombas Boyser, S.L.

c/ Miquel Martí i Pol, s/n - Pol. Ind. Pla de la Costa
08182 Sant Feliu de Codines - Barcelona - Spain

Tel. +34 93 844 77 78 info@boyser.com

www.boyser.com

